



surelight

Neon light SD Range Specification

NE-SD-HB



Table of Contents

Introduction	03
1. Specifications & Parameters	04
1.1 Dimensions of Light	
1.2 Technical Parameters	
1.3 Optical Parameters	
2. Functions & Features	05
2.1 Product Features	
2.2 Minimum Bend Diameter	
3. Types of Connector	05
3.1 Injection-Moulded Connector	
3.2 Dual Injection-Moulded Connector	
3.3 Sleeve Connector	
3.4 Screw Connector	
3.5 Clasp Connector	
3.6 Snap Connector	
3.7 Swivel Connector	
3.8 Anti-wicking Ferrule	
3.9 Male & Female Connector	
4. Mounting Profile	13
4.1 Standard Aluminum Profile	
4.2 Plastic Profile	
4.3 Self-locking Aluminum Profile Ver	
4.4 Self-locking Aluminum Profile Ver. 2	
4.5 Plastic & Aluminum Combination Profile	
4.6 Cable Exit Oriented Aluminum Profile	
(Applicable to Injection-moulded Connector Only)	
4.7 Corner Aluminum Profile	
(Applicable to Injection-moulded Connector Only)	
4.8 Curve Stainless Steel Profile	
5. Packaging	18
6. Appendix	19
6.2 Certificate	
6.3 Third-Party Test Report	
6.4 Reliability Test of Light	
6.5 Figures of Typical Characteristics	
6.6 (X,Y) Chromaticity Diagram	
6.7 Wavelength of Colour Light	
6.8 Loading Chart	
6.9 Correlated Colour Temperature	

Introduction

NE-SD-HB is a member of the Artist of Light series with smooth flat exterior that allows various monochromatic lighting solutions and produces superior homogenized illumination along its full length.

Built-in protection circuit design which means single LED failure has no effect on other LEDs working in the same unit and the whole light can keep constant lighting.

NE-SD-HB is UL/cUL, CE, TUV and RoHS compliant. Moreover, it has passed environmental resistance, optical, mechanical and electrical tests in our lab under the support of advanced experimental equipments and technology to ensure it meets the requirements of harsh environments. Also it has passed relevant tests of third party inspection authority.

Fully encapsulated in the flexible PVC chamber by utilizing consummate extrusion technology, assembled with multiple patented connectors to achieve IP68 protection, easy for installation and applicable for various circumstances.

NE-SD features bright, solid illumination, and ultra flexibility with small bend diameter in curve bending shape.

Applications:

1. Outdoor or Indoor Contour/Border Lighting
2. Architectural Outline/Decorative Lighting
3. Cove/Accent Lighting
4. Facade/Floor Lighting
5. Signage/Guide Lighting

1. Specifications & Parameters

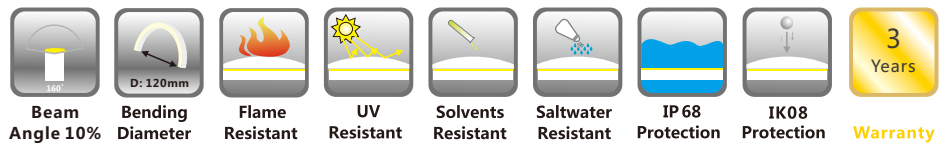

1.1 Dimensions of Light

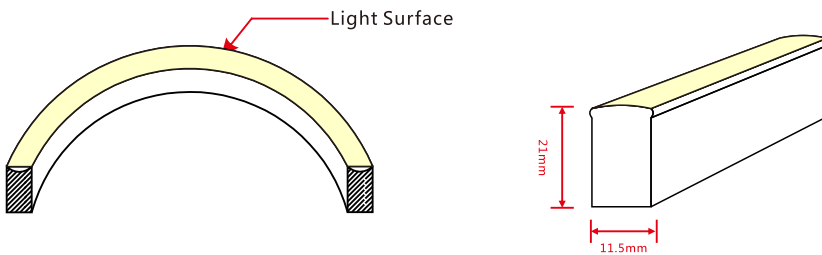

Note: Unless otherwise stated, the tolerance of the light is $\pm 0.3\text{mm}$.

1.2 Technical Parameters

Technical Parameters

Article No.	NE-SD-XXX-HB	NE-SD-XXX-HB
Colour	Red/Amber	Green/Blue/White
Working Voltage	DC24V	DC24V
Rated Power/m	7.2W	12W
LED Qty/m	60	60
LED Distance	16.67mm	16.67mm
Min. Cutting Unit	10LEDs(1unit)	6LEDs(1unit)
Min. Cutting Length	166.7mm(1unit)	100mm(1unit)
Continuous Length	15m	10m
Weight/m	325g	
Storage Temperature	-20 ~ 60°C	
Environmental Working Temperature	-20 ~ 45°C	
Environmental Installation Temperature	0 ~ 45°C	
IP Rating	IP68	

1.3 Optical Parameters

Photometric Data

Article No.	NE-SD-XXX-HB		NE-SD-XXX-HB		
LED Type	SMD		SMD		
Beam Angle 10%	160°		160°		
Colour	Wavelength	Lumen/m	Colour	CCT	Lumen/m
Red	620-630nm	>110lm	2500K	/	/
Green	520-530nm	>220lm	2700K	2725±145K	>280lm
Blue	465-475nm	>35lm	3000K	3045±175K	>280lm
Amber	585-595nm	>110lm	3500K	3465±245K	>320lm
			4000K	3985±275K	>320lm
			4500K	4503±243K	>320lm
			5000K	5029±283K	>320lm
			5700K	5669±355K	>320lm
			6500K	6532±510K	>320lm

Candle power distribution

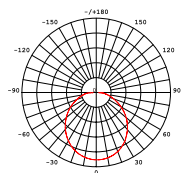

Illuminance Characteristics

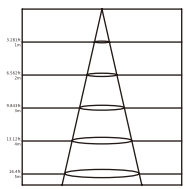

2. Functions & Features

2.1 Product Features

1. High quality and high brightness SMD LED chip.
2. Variety of monochromatic lights for option including Red, Green, Blue, Amber and White light.
3. UV & flame resistant construction(PVC).
4. Flat profile, good choice for recessed mounting.
5. High colour consistency & smooth illumination with invisible light dots.
6. Flexible with 120mm minimum bending diameter.
7. Easy installation and assembly with DIY accessories for joining and terminating.
8. High IP rating(IP68).
9. The product IP rate is ultimately in line with properly applied IP rated connectors.
10. Continuous length up to 15m (R, A) / 10m (G, B, W) by powering one end.
11. Environmentally friendly & energy efficient.
12. Automated production, high reliability & long warranty.
13. 5 years life span.

2.2 Minimum Bend Diameter

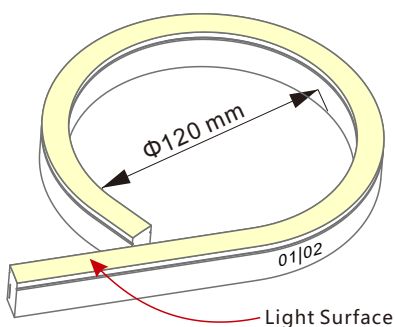

The light can only be bent laterally (opposite bend along to light surface).

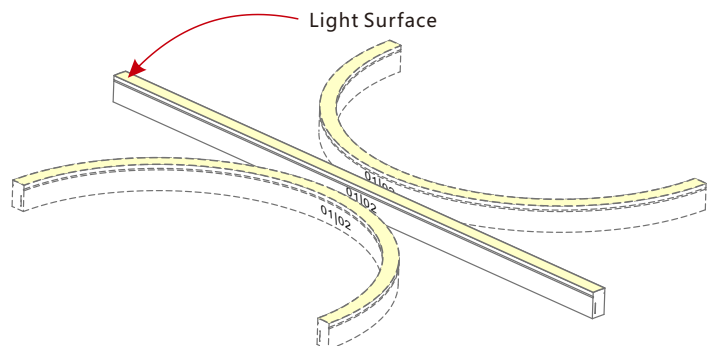

Do not bend smaller than allowed minimum bend diameter.

3. Types of Connector

3.1 Injection-moulded Connector

Note: Unless otherwise stated, the tolerance of the connector is $\pm 0.5 \text{ mm}$.



Injection-moulded Front Connector (bottom)

Connects light to power supply with pre-installed bottom feed cable, IP67. Cable length available in 0.3m, 1m, 3m, 5m, 10m, 15m, 20m.

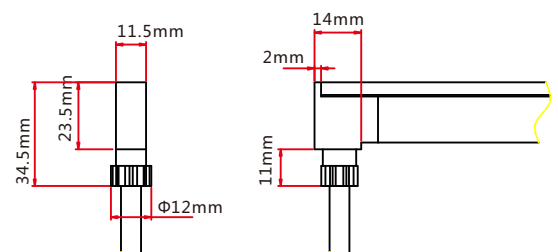

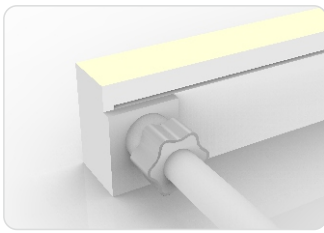

Injection-moulded Front Connector (side)

Connects light to power supply with pre-installed side feed cable, IP67. Cable length available in 0.3m, 1m, 3m, 5m, 10m, 15m, 20m.

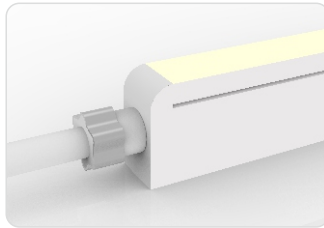
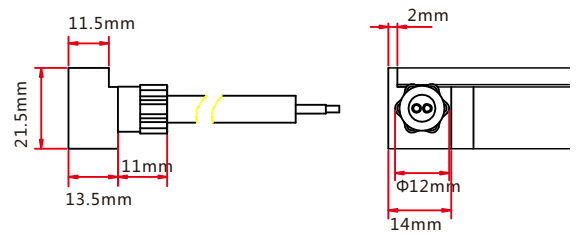

Injection-moulded Front Connector (top end)

Connects light to power supply with pre-installed end feed cable, IP67. Cable length available in 0.3m, 1m, 3m, 5m, 10m, 15m, 20m.

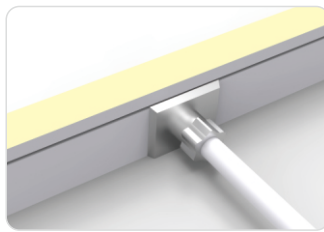
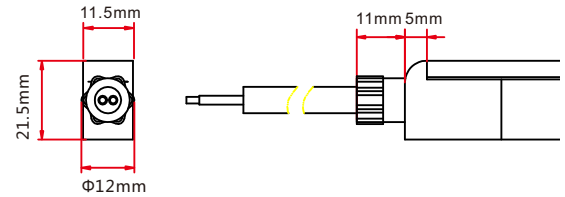

Injection-moulded Middle Feed Connector

Connects light to power supply with pre-installed end feed cable, IP67. Cable length available in 0.3m, 1m, 3m, 5m, 10m, 15m, 20m.

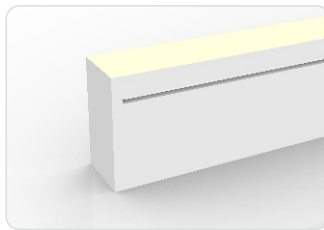
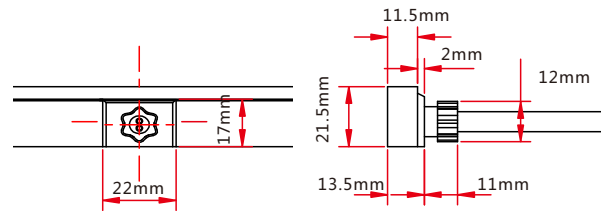

Injection-moulded End Cap

Pre-installed termination protection of the light, IP67.

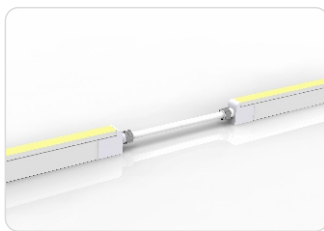
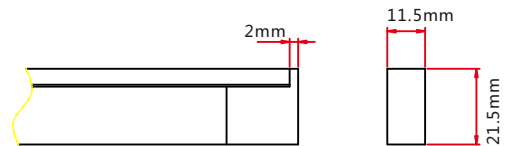

Injection-moulded Jumper

Connects two pieces of lights together with a flexible cable. IP67 Injection-moulded connector. L available in 0.3~1m.

Maximum 8 Jumpers in 20m
Maximum 4 Jumpers in 10m

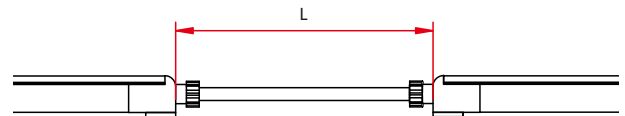

Injection-moulded T-feed

Connects two pieces of lights together with a T joint, energized from middle. IP67 Injection-moulded connector. L1 and L2 available in 0.15~0.5m. L3 available in 0.3-3m.

Maximum 8 T-feeds in 20m
Maximum 4 T-feeds in 10m

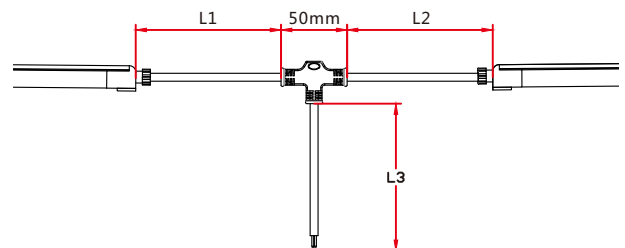

3.2 Dual Injection-moulded Connector

Note: Unless otherwise stated, the tolerance of the connector is $\pm 0.5\text{mm}$.

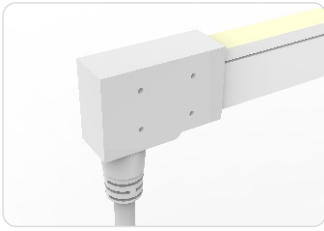

Dual Injection-moulded Front Connector (bottom)

Connects light to power supply with pre-installed bottom feed cable, IP68. Cable length available in 0.3m, 1m, 3m, 5m, 10m, 15m, 20m.

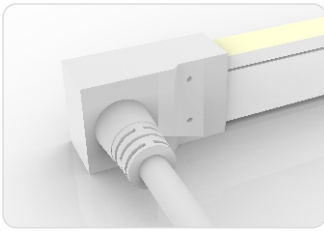
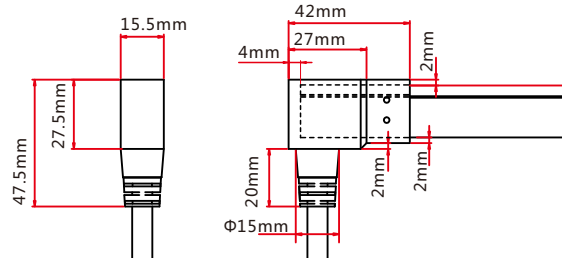

Dual Injection-moulded Front Connector (side)

Connects light to power supply with pre-installed side feed cable, IP68. Cable length available in 0.3m, 1m, 3m, 5m, 10m, 15m, 20m.

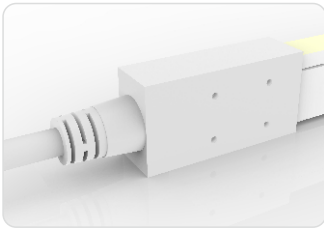
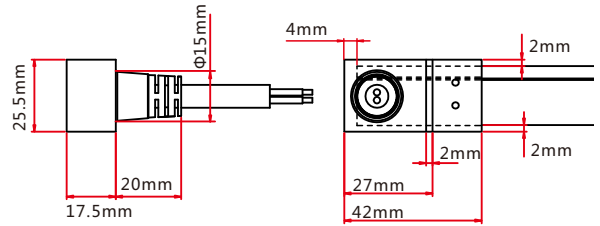

Dual Injection-moulded Front Connector (top end)

Connects light to power supply with pre-installed end feed cable, IP68. Cable length available in 0.3m, 1m, 3m, 5m, 10m, 15m, 20m.

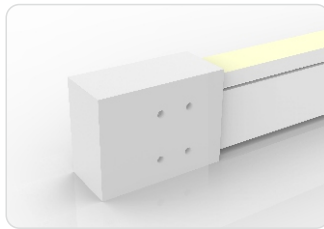
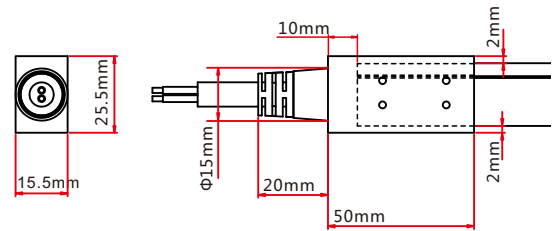

Dual Injection-moulded End Cap

Pre-installed termination protection of the light, IP68.

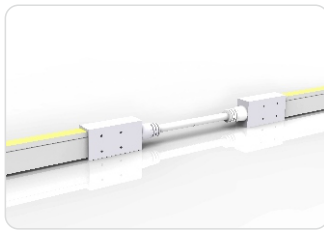
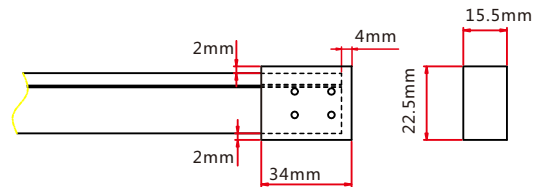

Dual Injection-moulded Jumper

Connects two pieces of lights together with a flexible cable. IP68 Dual Injection-moulded connector. L available in 0.3~1m.

Maximum 8 Jumpers in 20m
Maximum 4 Jumpers in 10m

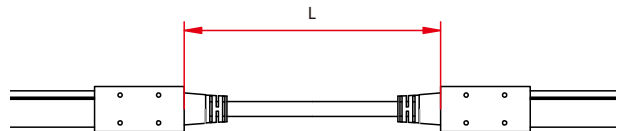

Dual Injection-moulded T-feed

Connects two pieces of lights together with a T joint, energized from middle. IP68 Dual Injection-moulded connector. L1 and L2 available in 0.15~0.5m. L3 available in 0.3~3m.

Maximum 8 T-feeds in 20m
Maximum 4 T-feeds in 10m

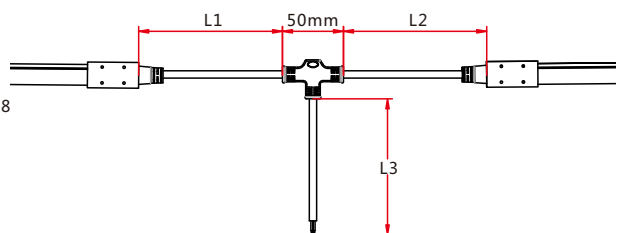

3.3 Sleeve Connector

Note: Unless otherwise stated, the tolerance of the connector is $\pm 0.5\text{mm}$.

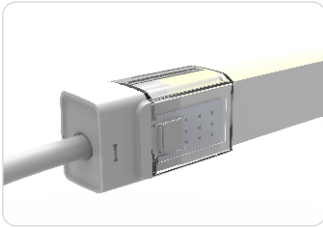

Sleeve Front Connector

Connects light to power supply. IP40 DIY connector. Cable length available in 0.3m, 1m, 3m, 5m, 10m, 15m, 20m.

Feed connector*1 (Two-pin)
PC cover*1
Anti-skidding clips*2

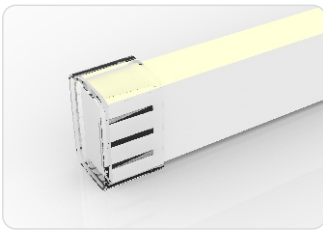
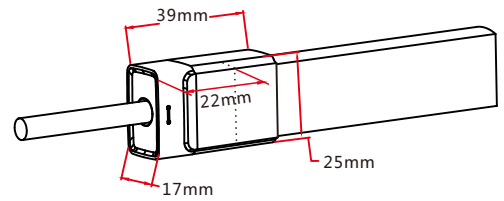

Sleeve End Cap

Termination protection of the light. IP40 DIY connector.

Shading Sheat*1
PC cover*1

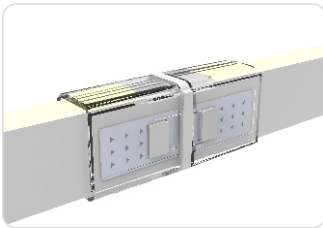
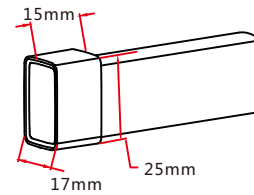

Sleeve Middle Connector

Combine two pieces of lights together. DIY connector.

Pin connector*1 (Two-pin)
PC cover*2
Anti-skidding clips*4

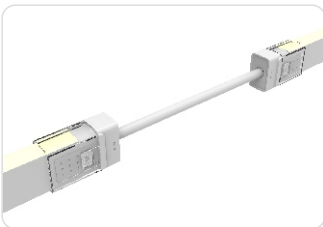
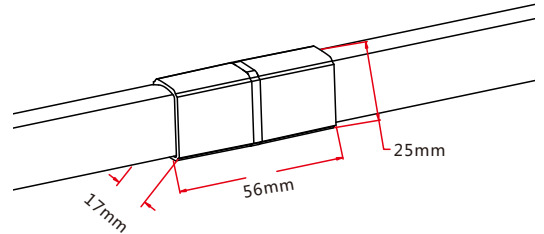

Sleeve Jumper

Connects two pieces of lights together with a flexible cable. IP40 DIY connector. L available in 0.3m, 1m and 3m.

Double-end feed connector*1 (Two-pin)
PC cover*2
Anti-skidding clips*4

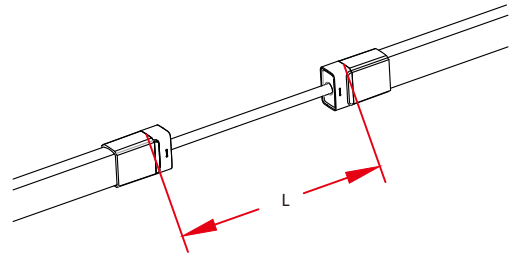

Sleeve Power T-feed

Connects two pieces of lights together with a T joint, energized from middle. IP40 DIY connector. L1 and L2 available in 0.3m.

T joint*1 (Two-pin)
PC cover*2
Anti-skidding clips*4

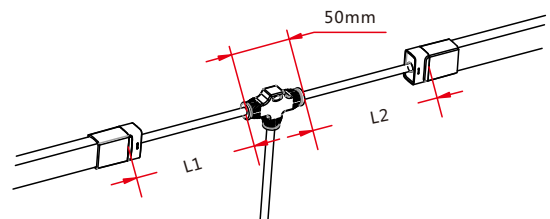

3.4 Screw Connector

Note: Unless otherwise stated, the tolerance of the connector is $\pm 0.5\text{mm}$.

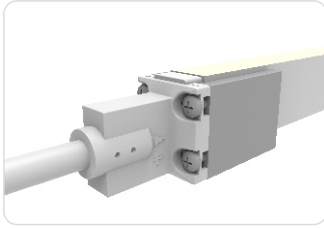

Screw Front Connector

Connects light to power supply. IP67 DIY connector. Cable length available in 0.3m, 1m, 3m, 5m, 10m, 15m, 20m.

- Feed connector*1 (Two-pin)
- Silicone gasket*1
- Aluminum mounting piece*1
- Anti-skidding clip*1
- Screw*4

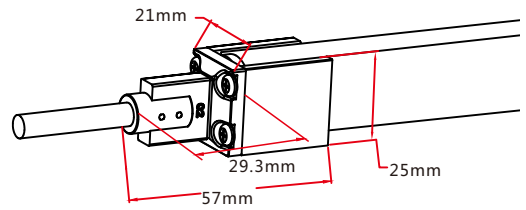

Screw Front Connector (bottom)

Termination protection of the light. IP67. DIY connector.

- Feed connector*1 (Two-pin)
- Silicone gasket*1
- Aluminum mounting piece*1
- Anti-skidding clip*1
- Screw*4

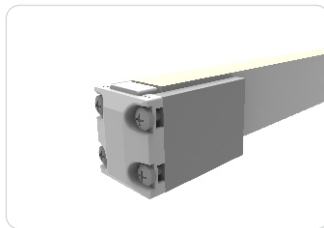
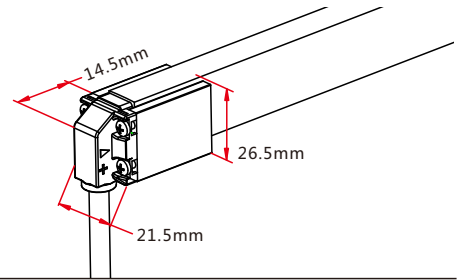

Screw End Cap

Termination protection of the light. IP67. DIY connector.

- Tail plug*1
- Silicone gasket*1
- Aluminum mounting piece*1
- Anti-skidding clip*1
- Screw*4

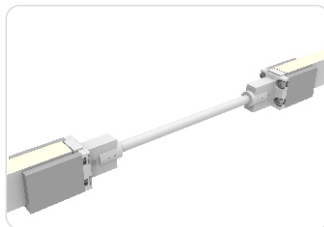
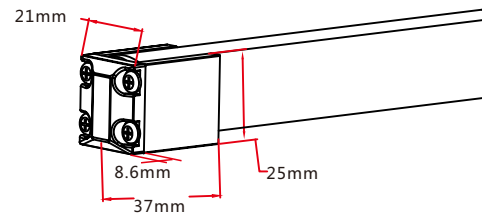

Screw Jumper

Connects two pieces of lights together with a flexible cable. IP67 DIY connector. L available in 0.3m, 1m and 3m.

- Double-end feed connector*1 (Two-pin)
- Silicone gasket*2
- Aluminum mounting piece*2
- Anti-skidding clip*2
- Screw*8

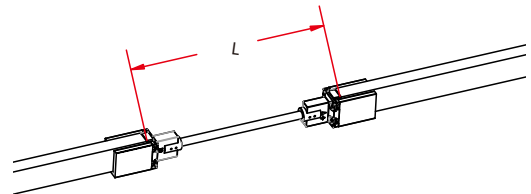

Screw Power T-feed

Connects two pieces of lights together with a T joint, energized from middle. IP67 DIY connector. L1 and L2 available in 0.3m.

- T joint*1 (Two-pin)
- Silicone gasket*2
- Aluminum mounting piece*2
- Anti-skidding clip*2
- Screw*8

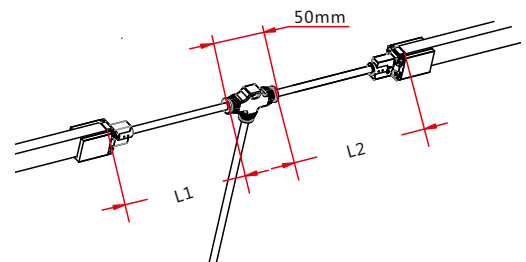

3.5 Clasp Connector

Note: Unless otherwise stated, the tolerance of the connector is $\pm 0.5\text{mm}$.

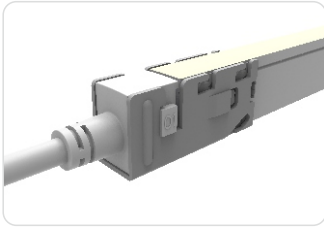

Clasp Front Connector

Connects light to power supply. IP67 DIY connector. Cable length available in 0.3m, 1m, 3m, 5m, 10m, 15m, 20m.

- Feed connector*1 (Two-pin)
- Silicone gasket*1
- U steel plate*1
- Anti-skidding clip*1

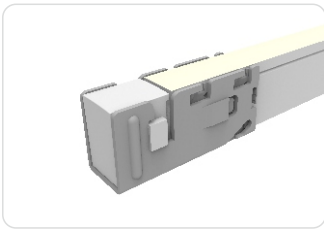
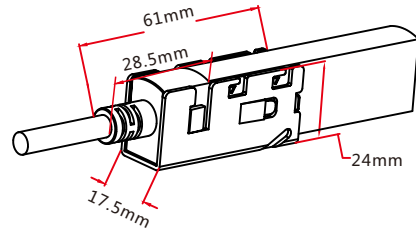

Clasp End Cap

Termination protection of the light. IP67 DIY connector.

- Tail plug*1
- Silicone gasket*1
- U steel plate*1
- Anti-skidding clip*1

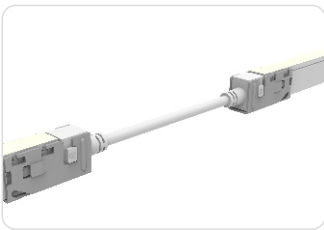
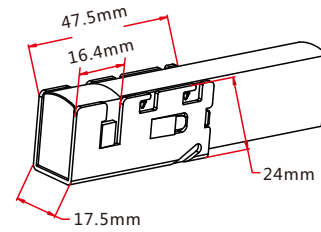

Clasp Jumper

Connects two pieces of lights together with a flexible cable. IP67 DIY connector. L available in 0.3m, 1m and 3m.

- Double-end feed connector*1 (Two-pin)
- Silicone gasket*2
- U steel plate*2
- Anti-skidding clip*2

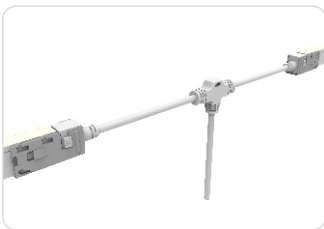
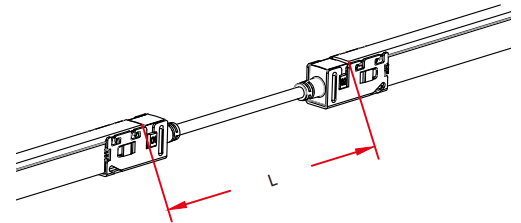

Clasp Power T-feed

Connects two pieces of lights together with a T joint, energized from middle. IP67 DIY connector. L1 and L2 available in 0.3m.

- T joint*1 (Two-pin)
- Silicone gasket*2
- U steel plate*2
- Anti-skidding clip*2

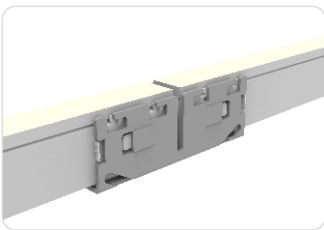
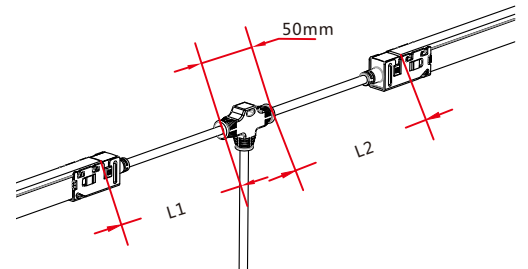

Seamless Middle Connector

Connects two pieces of lights together seamlessly. IP40 DIY connector.

- Silicone gasket*1
- Joint PCB*1
- U steel plate*2
- Anti-skidding clip*2

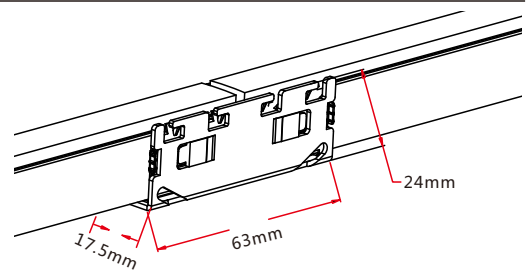

3.6 Snap Connector

Note: Unless otherwise stated, the tolerance of the connector is $\pm 0.5\text{mm}$.

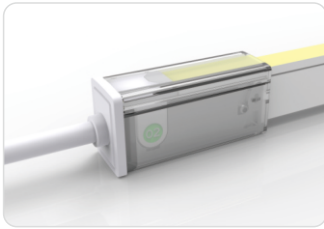

Snap Front Connector(top end)

Connects light to power supply. IP67
DIY connector. Cable length available
in 0.3m, 1m, 3m, 5m, 10m, 15m, 20m.

- Feed connector*1 (Two-pin)
- Silicone gasket*1
- U steel plate*1
- Anti-skidding clip*1
- PC Cover*1

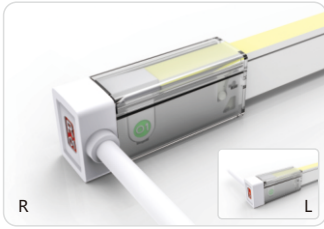
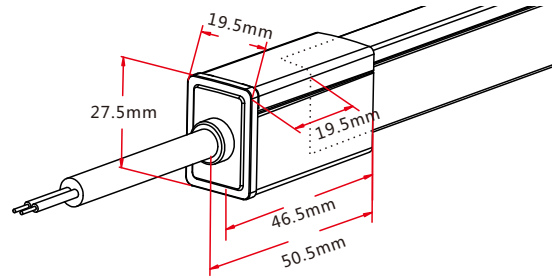

Snap Front Connector(side right/left)

Connects light to power supply. IP67
DIY connector. Cable length available
in 0.3m, 1m, 3m, 5m, 10m, 15m, 20m.

- Feed connector*1 (Two-pin)
- Silicone gasket*1
- U steel plate*1
- Anti-skidding clip*1
- PC Cover*1

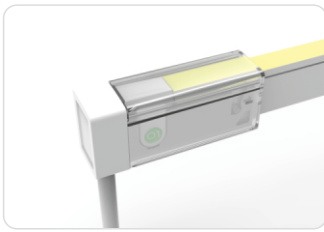
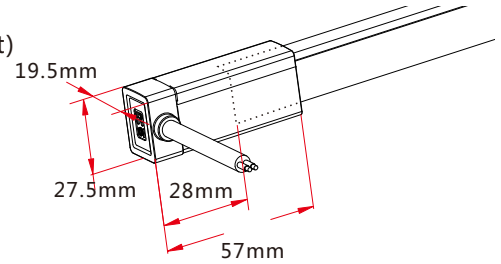

Snap Front Connector(bottom)

Connects light to power supply. IP67
DIY connector. Cable length available
in 0.3m, 1m, 3m, 5m, 10m, 15m, 20m.

- Feed connector*1 (Two-pin)
- Silicone gasket*1
- U steel plate*1
- Anti-skidding clip*1
- PC Cover*1

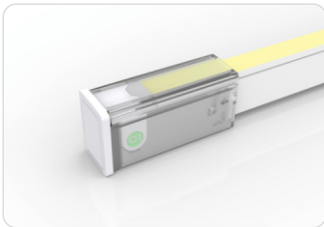
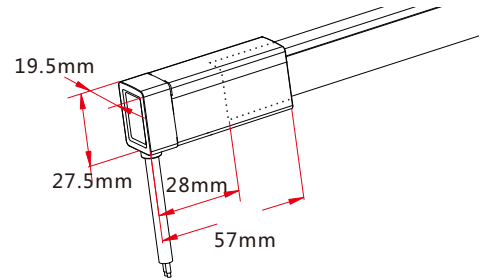

Snap End Cap

Termination protection of the light.
IP67. DIY connector.

- Tail plug*1
- Silicone gasket*1
- U steel plate*1
- Anti-skidding clip*1
- PC Cover*1

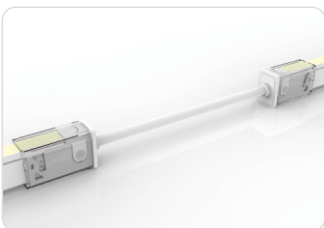
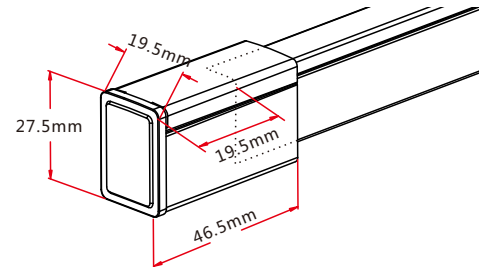

Snap Jumper

Connects two pieces of lights together
with a flexible cable. IP67 DIY connector.
L available in 0.3m, 1m and 3m.

- Double-end feed connector*1 (Two-pin)
- Silicone gasket*2
- U steel plate*2
- Anti-skidding clip*2
- PC Cover*2

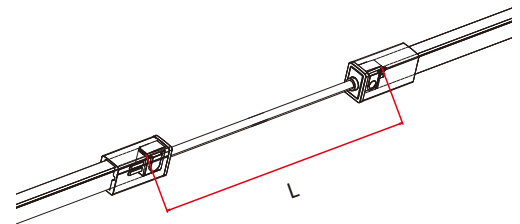

Snap Power T-feed

Connects two pieces of lights together
with a T joint, energized from middle. IP67
DIY connector. L1 and L2 available in 0.3m.

- T joint*1 (Two-pin)
- Silicone gasket*2
- U steel plate*2
- Anti-skidding clip*2
- PC Cover*2

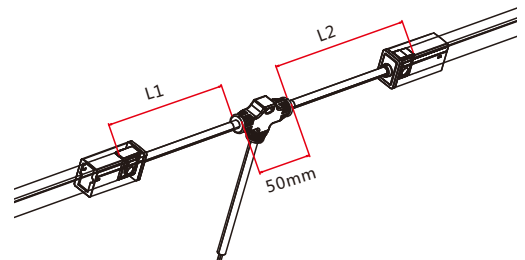

3.7 Swivel Connector

Note: Unless otherwise stated, the tolerance of the connector is $\pm 0.5\text{mm}$.

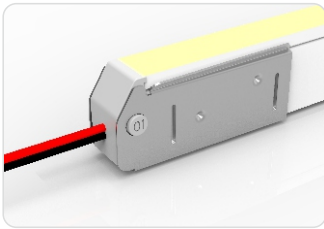

Swivel Front Connector (top end)

Connects light to power supply. IP20 DIY connector. Cable length available in 0.3m, 1m.

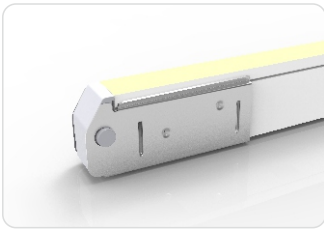
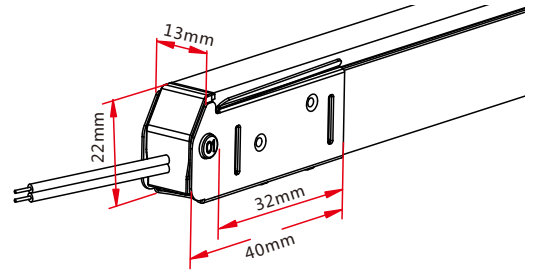

Swivel End Cap

Termination protection of the light, IP20 DIY connector.

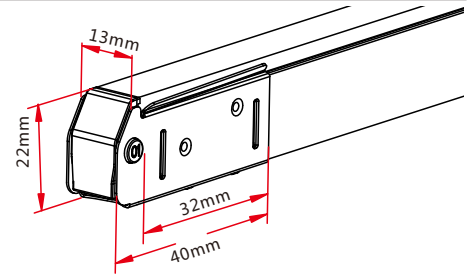

3.8 Anti-wicking Ferrule

Note: Unless otherwise stated, the tolerance is $\pm 0.5\text{mm}$.

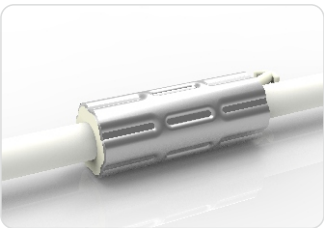

Anti-wicking Ferrule

The anti-wicking ferrule is located at 115mm ($\pm 5\text{mm}$ tolerance) from the connector on the cable.

For protection against water ingress from inside of cable wire and hence damage the light.

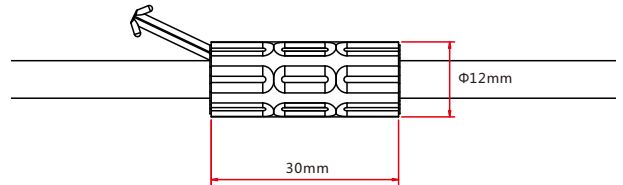

3.9 Male & Female Connector

Note: Unless otherwise stated, the tolerance is $\pm 2\text{mm}$.

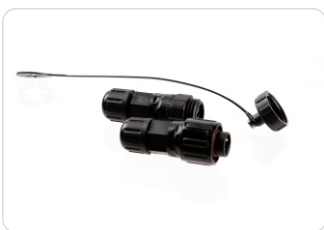

Male & female Connector

For plug and play cable junction, DIY or Pre-installed connector, IP68

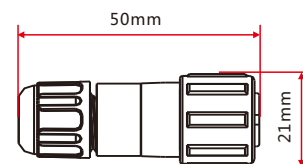

4. Mounting Profile

4.1 Standard Aluminum Profile

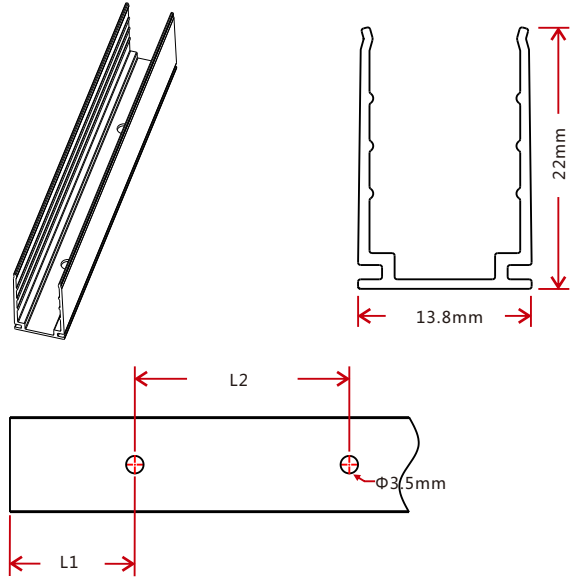
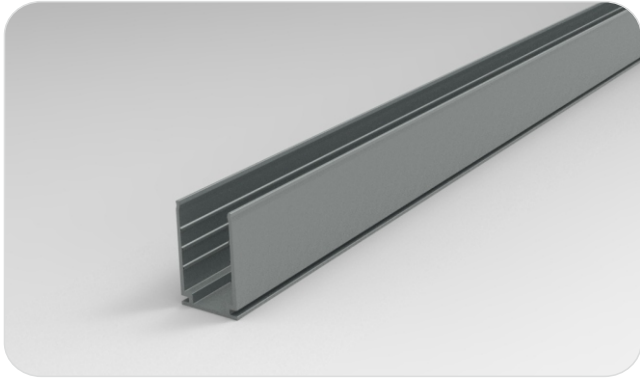

Note: Unless otherwise stated, the tolerance of the profile is ±0.5mm.

Model	W*H(mm)	Standard Length (mm)	L1 (mm)	L2 (mm)	Screw Hole (mm)	Hole Number	For Product
NE-SD-CH	13.8*22	35	17.5	/	Φ3.5	1	SD/XL
		500	50	200	Φ3.5	3	SD/XL
		1000	100	200	Φ3.5	5	SD/XL
		2000	100	200	Φ3.5	10	SD/XL

4.2 Plastic Profile

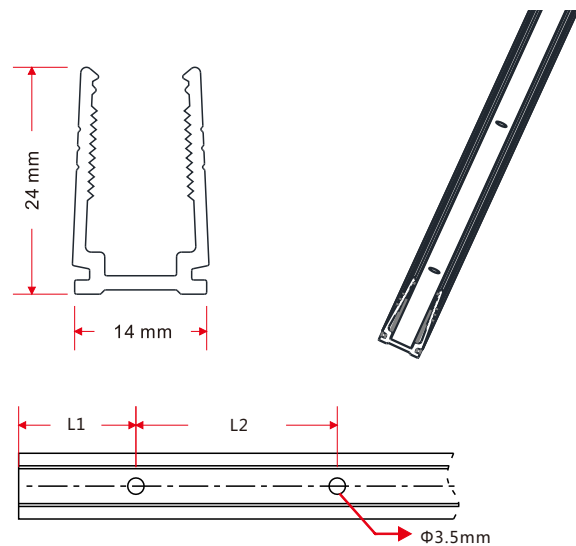
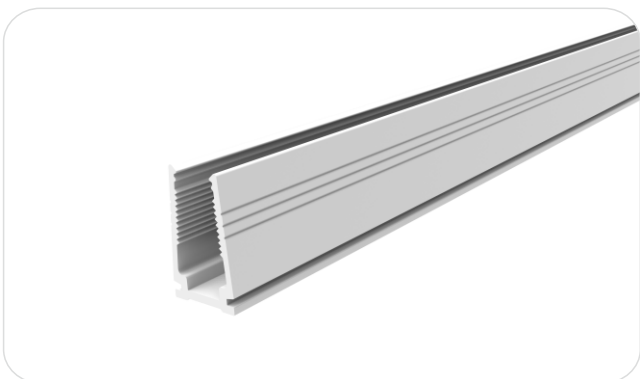

Note: Unless otherwise stated, the tolerance of the profile is ±0.5mm.

Model	W*H(mm)	Standard Length (mm)	L1 (mm)	L2 (mm)	Screw Hole (mm)	Hole Number	For Product
NE-SD-CH	14*24	500	50	200	Φ3.5	3	SD/XL
		1000	100	200	Φ3.5	5	SD/XL
		2000	100	200	Φ3.5	10	SD/XL

4.3 Self-locking Aluminum Profile (Using with the Clip)

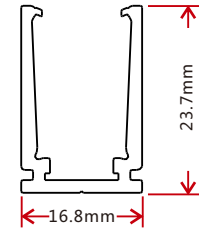
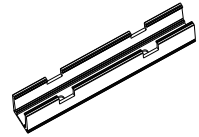
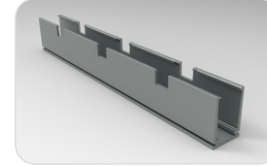
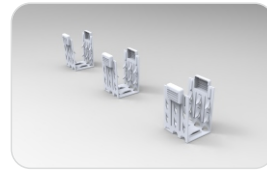
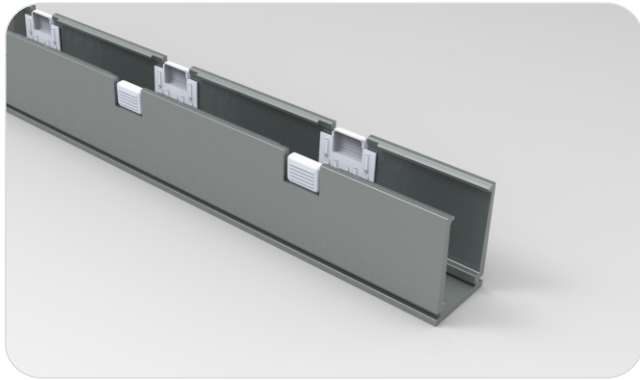

Note: Unless otherwise stated, the tolerance of the profile is $\pm 0.5\text{mm}$.

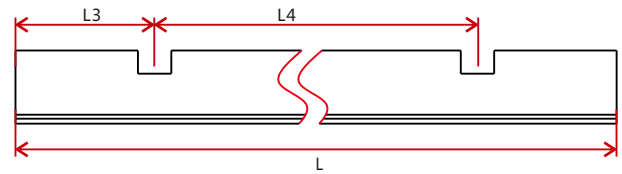
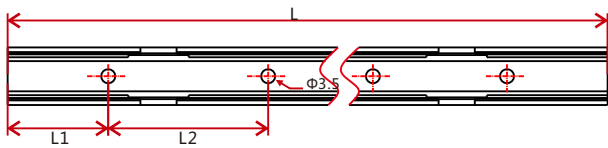

Model	W*H(mm)	Standard Length(mm)	L1(mm)	L2(mm)	L3(mm)	L4(mm)	Hole Screw(mm)	Hole Number	Clip Number
NE-SD-CH	16.8*23.7	35	17.5	25	5	/	$\Phi 3.5$	2	1
		500	50	200	75	350	$\Phi 3.5$	3	2
		1000	100	200	150	350	$\Phi 3.5$	5	3
		2000	100	200	125	350	$\Phi 3.5$	10	6

4.4 Self-locking Aluminum Profile Ver 2.0 (Using with the Clip)

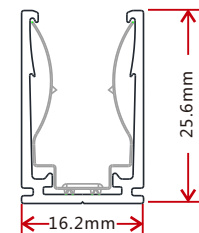
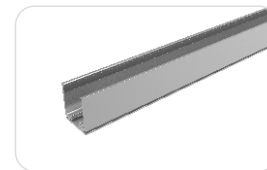

Note: Unless otherwise stated, the tolerance of the profile is $\pm 0.5\text{mm}$.

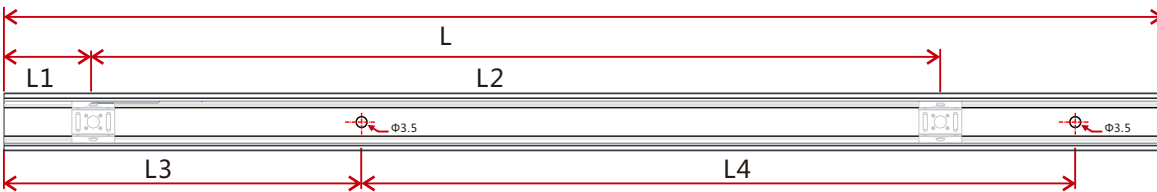

Model	W*H(mm)	Standard Length(mm)	L1(mm)	L2(mm)	L3(mm)	L4(mm)	Hole Screw(mm)	Hole Number	Clip Number
NE-SD-CH	16.2*25.6	35	17.5	/	5	25	$\Phi 3.5$	2	1
		500	25	225	50	200	$\Phi 3.5$	3	3
		1000	25	237.5	100	200	$\Phi 3.5$	5	5
		2000	25	243.8	100	200	$\Phi 3.5$	10	9

4.5 Plastic & Aluminum Combination Profile

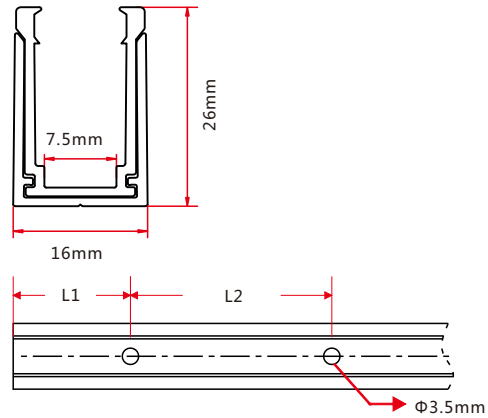
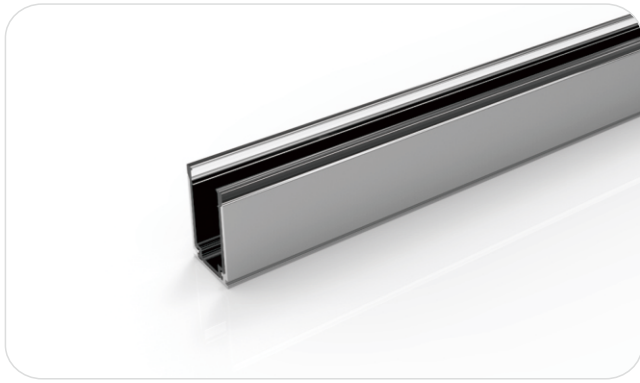

Model	W*H(mm)	Standard Length (mm)	L1 (mm)	L2 (mm)	Screw Hole (mm)	Hole Number	For Product
NE-SD-CH	16*26	35	17.5	/	Φ3.5	1	SD/XL
		500	50	200	Φ3.5	3	SD/XL
		1000	100	200	Φ3.5	5	SD/XL
		2000	100	200	Φ3.5	10	SD/XL

4.6 Cable Exit Oriented Aluminum Profile (Applicable to Injection-moulded Connector Only)

4.6.1 Self-locking Aluminum Profile Ver. 2, Middle Feed (Using with the Clip)

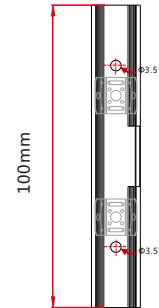
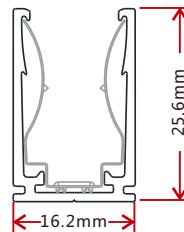
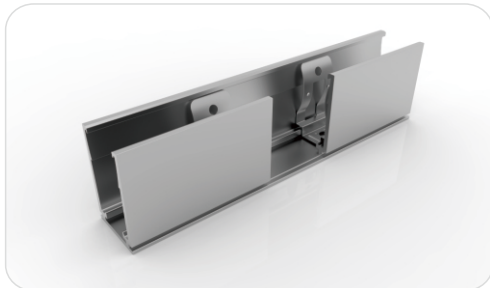

Model: NE-SD-CH

Note: Unless otherwise stated, the tolerance of the profile is ±0.5mm.

4.6.2 Self-locking Aluminum Profile Ver. 2, Side Feed From Left (Using with the Clip)

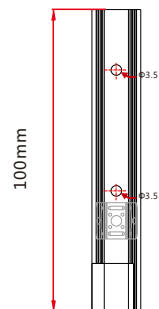
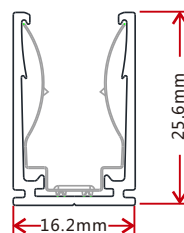

Model: NE-SD-CH

Note: Unless otherwise stated, the tolerance of the profile is ±0.5mm.

4.6.3 Self-locking Aluminum Profile Ver. 2, Bottom Feed (Using with the Clip)

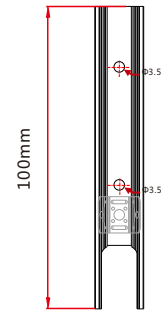
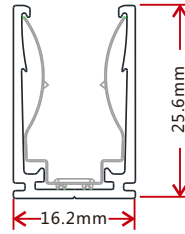
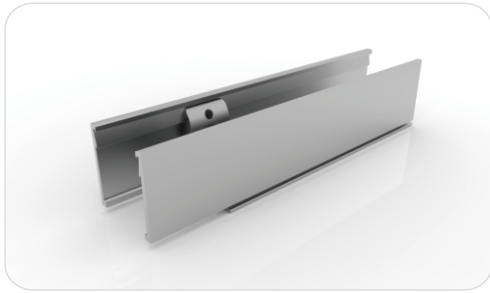

Model: NE-SD-CH

Note: Unless otherwise stated, the tolerance of the profile is $\pm 0.5\text{mm}$.

4.6.4 Self-locking Aluminum Profile Ver. 2, Side Feed From Right (Using with the Clip)

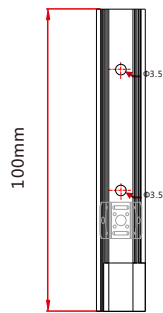
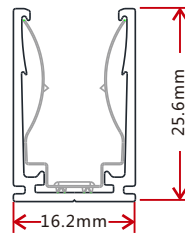
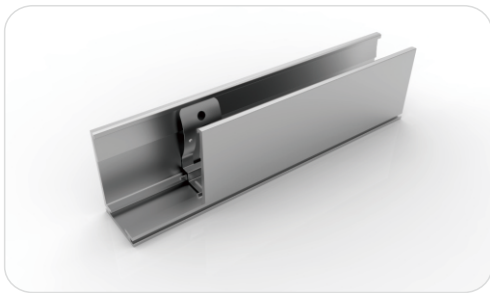

Model: NE-SD-CH

Note: Unless otherwise stated, the tolerance of the profile is $\pm 0.5\text{mm}$.

4.7 Corner Aluminum Profile (Applicable to Injection-moulded Connector Only)

4.7.1 L Shape Self-locking Aluminum Profile Ver. 2 (Using with the Clip)

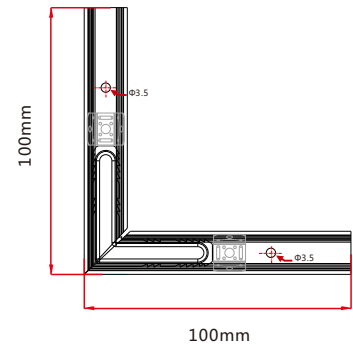
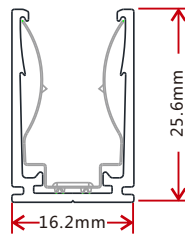

Model: NE-SD-CH

Note: Unless otherwise stated, the tolerance of the profile is $\pm 0.5\text{mm}$.

4.7.2 Inward L Shape Self-locking Aluminum Profile Ver.2 (Using with the Clip)

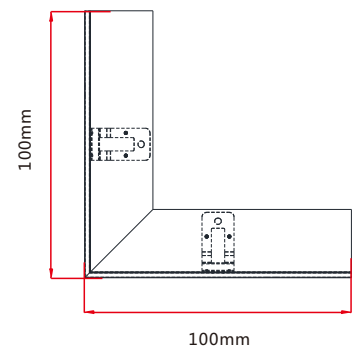
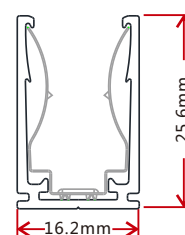

Model: NE-SD-CH

Note: Unless otherwise stated, the tolerance of the profile is $\pm 0.5\text{mm}$.

4.7.3 Outward L Shape Self-locking Aluminum Profile Ver.2 (Using with the Clip)

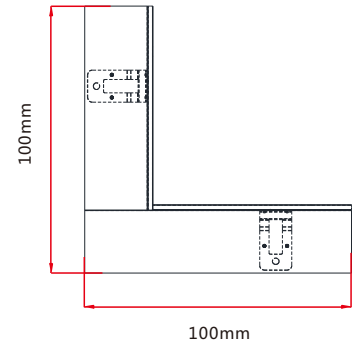
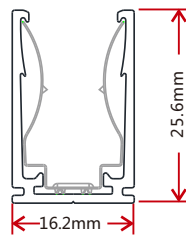
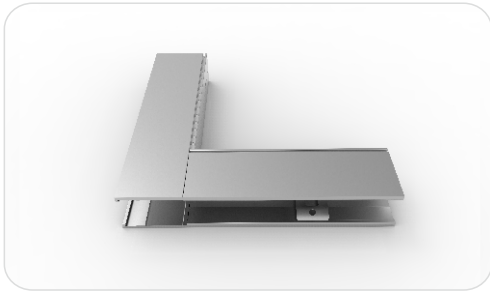

Model: NE-SD-CH

Note: Unless otherwise stated, the tolerance of the profile is $\pm 0.5\text{mm}$.

4.7.4 T Shape Self-locking Aluminum Profile Ver. 2 (Using with the Clip)

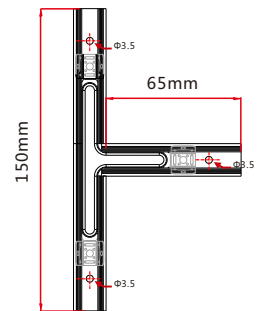
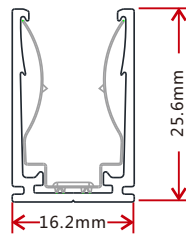
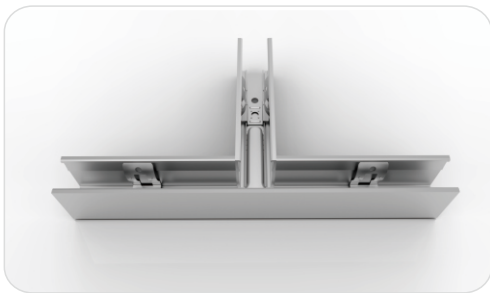

Model: NE-SD-CH

Note: Unless otherwise stated, the tolerance of the profile is $\pm 0.5\text{mm}$.

4.7.5 X Shape Self-locking Aluminum Profile Ver. 2 (Using with the Clip)

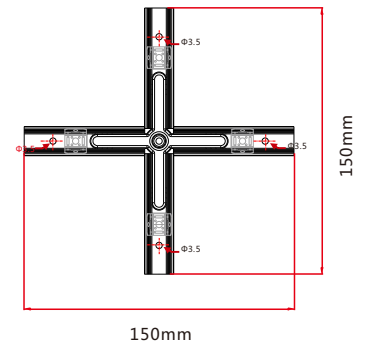
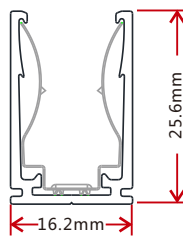
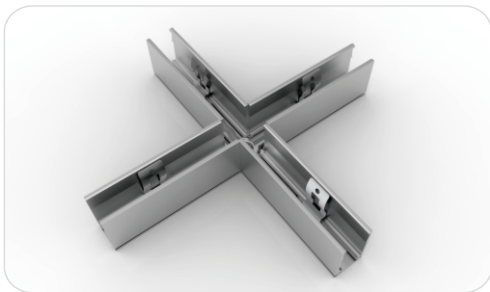

Model: NE-SD-CH

Note: Unless otherwise stated, the tolerance of the profile is $\pm 0.5\text{mm}$.

4.8 Curve Stainless Steel Profile

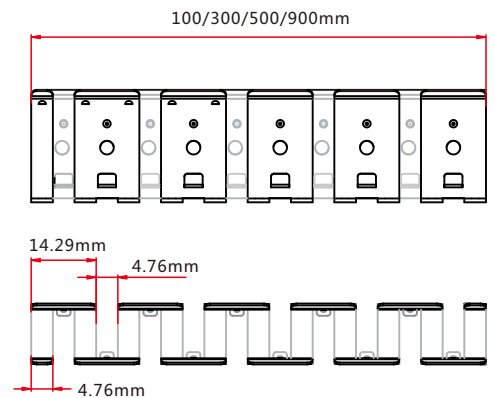
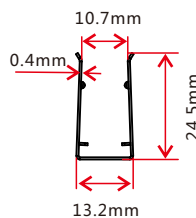
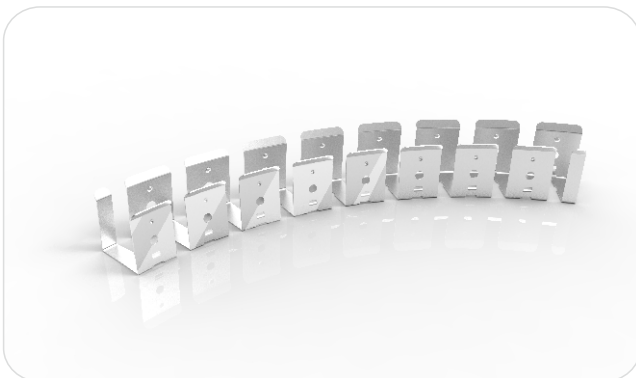

Model: NE-SD-CH

Note: Unless otherwise stated, the tolerance of the profile is $\pm 0.5\text{mm}$.

5.Packaging

Packaging Method

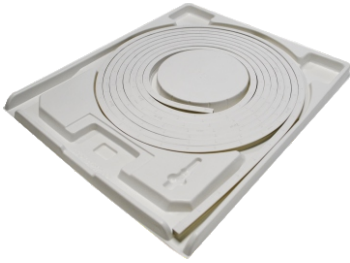

Plastic Plate

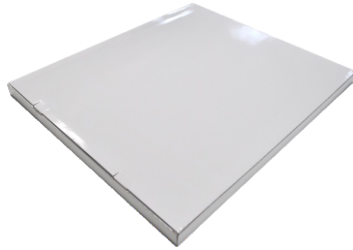

White Box



Carton



Packaging Detail

Light Length	White Box Dimension (cm)	Carton Dimension (cm)	Numbers of White Box	Carton Weight (kg)
5m	35*4.2*46	48*37*24	5	10
10m	45*4.2*56	58*47*24	5	18
20m	61*4.2*72	74*63.5*10.5	2	15

6. Appendix

6.1 Certificate

Certificating Type	Testing Organization	Certificate Serial Number	Report Reference
UL 2108	UL	20160726-E360029	E360029-20130322
CE-EMC	SGS	SZEM1702001259LMV	SZEM160600421302

6.2 Third-Party Test Report

Testing Item	Testing Organization	Report Number
RoHS	SGS	CANEC1202163502 A01
IP68: Screw type	TUV SUD	68.140.12.136.02
IP68: Clasp type	SGS	GZES140200135301 GZES140200135401 GZES140200135501 GZES140200135701 GZES140200135801
IPX8: Molding type	SGS	SZES141200357301 SZES141200357401 SZES141200357501
IPX8: Snap type	SGS	GZES160600792031
Flame retardant	TUV SUD	68.140.13.068.01
UV@340nm: Light	AOV	A002R130308065—1R01
UV@340nm: PVC	AOV	A002R130308065—2R01

>>Note: The testing reports and certificates are available from the related official website.

6.3 Reliability Test of Light

TESTING ITEM	PERFORMANCE	STANDARD/REFERENCE VALUE/DESCRIPTION
PHOTOMETRIC TESTING	Spectrum Analysis	IES LM 79 (lumen, CCT, CRI, XY, SDCM, wave length)
	Photometric Distribution	IES LM 79(lumen intensity distribution & Lux diagram)
	Lumen Maintenance & Life Time	IES LM84 & IES TM28
TEMPERATURE RISE TESTING	Normal Temperature Test	UL1598 & UL2388 & IEC60598-1 & IEC60598-2-21
	Abnormal Operation Test	UL1598 & UL2388 & IEC60598-1 & IEC60598-2-21
MECHANICS & PHYSICS TESTING	Bending Test	Manufacturer-defined, 500 cycles
	Swing Test	UL2388, >750 cycles
	Tensile Test	Manufacturer-defined, > the weight of light in
	Twist Test	maximum connection length with both ends feed
	Ball Impact	Manufacturer-defined, >200 cycles
	IK07 IK08	UL1598 & UL2388 & IEC60598-1 & IEC60598-2-21 IEC62262
WEATHERING TESTING	Swimming Pool Water Immersion Test	GB9667, PH6.8-7.6, free chlorine 0.3-0.6mg/L
	Sea Water Immersion Test	IEC60598-1, Salinity 4%
	Salt Spray Test	IEC68-2-11
	Outdoor Exposure	Manufacturer-defined
ENVIROMENT TESTING	Flame Resistant Test	UL94
	UV Exposure Test	ASTMG 154 , ISO 4892-3 , UVA@340nm
	IPX5 IPX6 IPX7 IPX8	IEC60529
ENDURANCE & THERMAL TEST LAB	Temperature Shock Test	Manufacturer-defined , -40°C-60°C (typical temperature range)
	Constant Temperature Test	Manufacturer-defined , 70°C (typical temperature)

6.4 Figures of Typical Characteristics

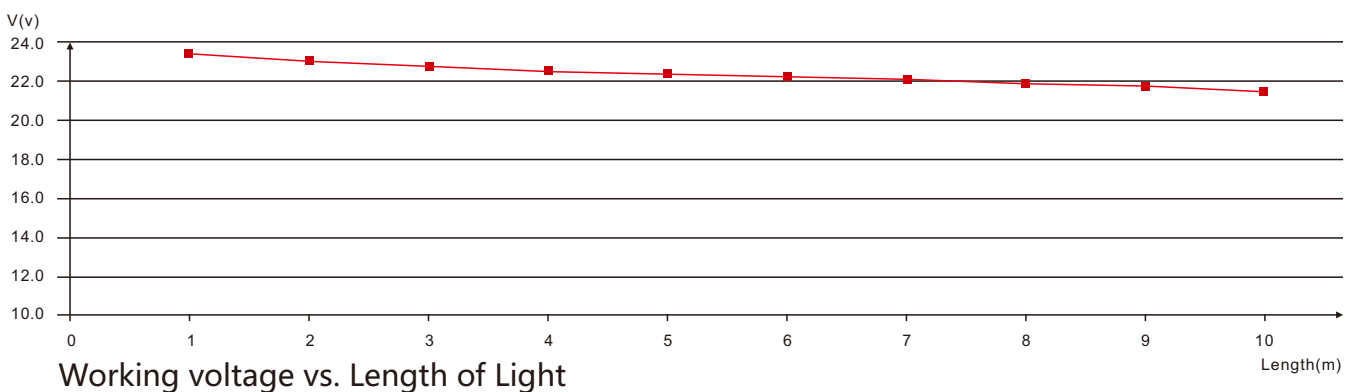
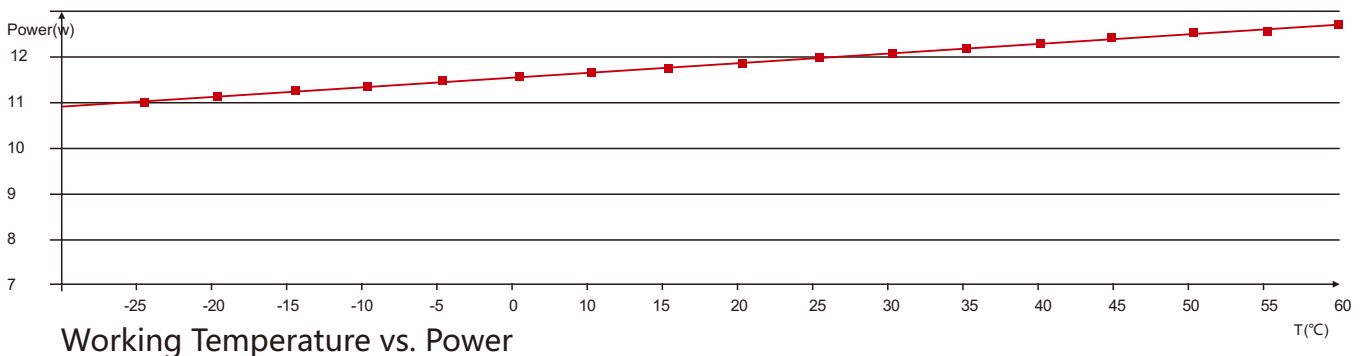

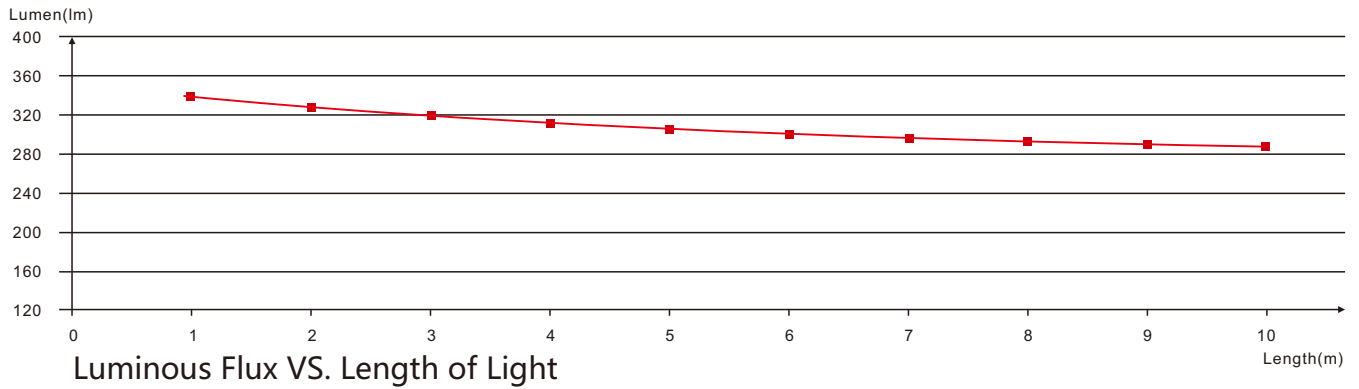

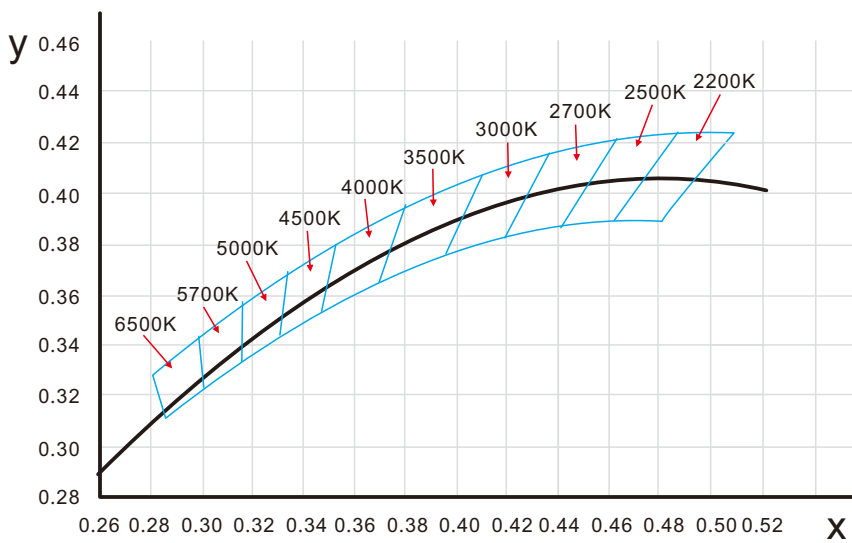

6.5 (X,Y) Chromaticity Diagram

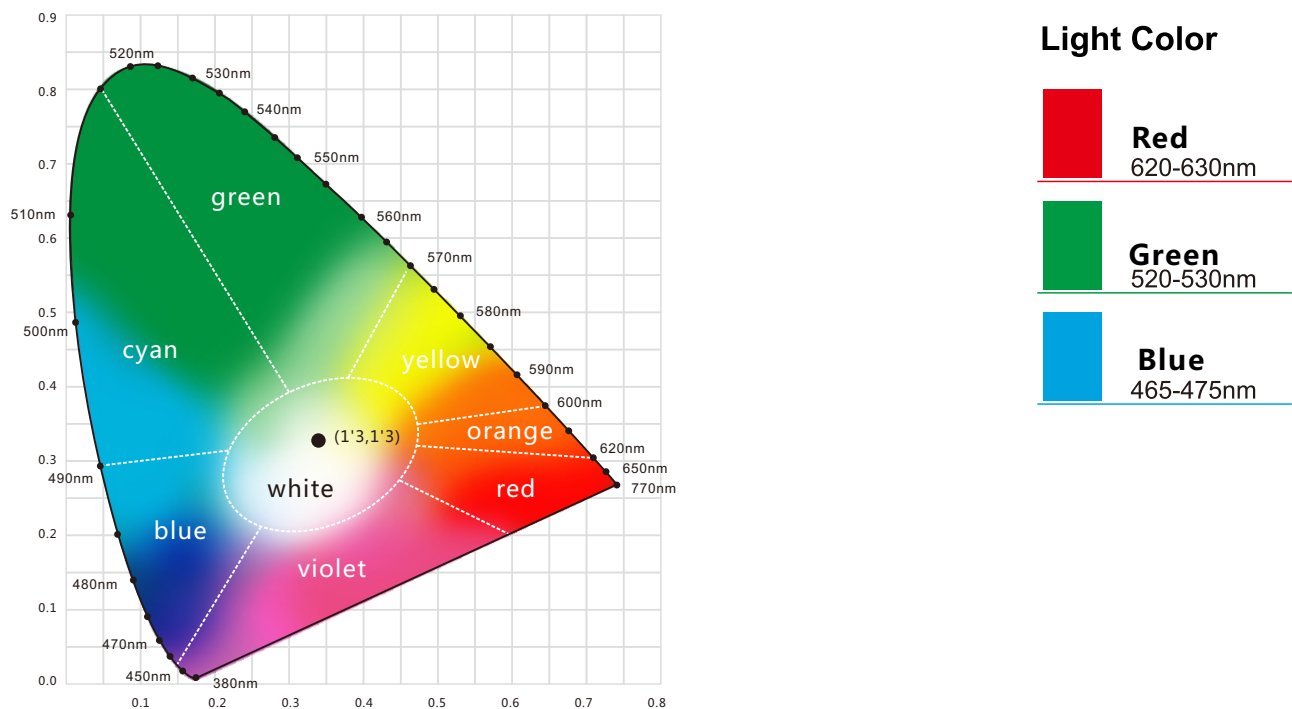

6.6 Wavelength of Colour Light

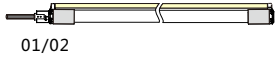

6.7 Loading Chart

Type.	Rated Power /mtr	Power Supply											
		35w	60w	75w	80w	100w	120w	150w	120w	150w	185w	240w	320w
NE-SD	6.5w/7.2w/8w	3m	6m	7.5m	8m	10m	12m	15m			18m	24m	30m
	10.6w/11w/12w	2m	3.5m	4.5m	5m	6m	7m	10m			12m	14m	20m
	15w	2m	3m	4m	4.2m	5m			6m	8m	10m		
Energizing Way		DC input 						DC input 					

Note : 1. These are the light maximum recommended running length subject to selected power supply.
 2. For example: It is recommended to use one 80W power supply loading maximum 8m light (7.2w/m) or maximum 5m light (12w/m) by energizing the light one end.

6.8 Correlated Colour Temperature

ANSI STANDARD

Nominal CCT Categories

Nominal CCT	Target CCT and tolerance(K)	Target D_{uv}	D_{uv} Tolerance Range
2200K	2238 ±102	0.0000	T_x :CCT of the source
2500K	2460±120	0.0000	For $T_x < 2870K$
2700K	2725 ±145	0.0000	0.000±0.0060
3000K	3045±175	0.0001	For $T_x \geq 2870K$
3500K	3465±245	0.0005	$D_{uv}(T_x) \pm 0.0060$
4000K	3985±275	0.0010	where
4500K	4503±243	0.0015	$D_{uv}(T_x) = 57700 \times (1/T_x)^2$
5000K	5029±283	0.0020	-44.6 x (1/ T_x)
5700K	5667±355	0.0025	+0.00854
6500K	6532±510	0.0031	
Flexible CCT (2200-6500K)	$T_f^{1)} \pm \Delta T^{2)}$	$D_{uv} T_f^{3)}$	

Remark:

- 1) T_f is chosen to be at 100K steps (2300,2400,.....,6400K),excluding the ten nominal CCTs listed in Table 1.
- 2) $\Delta T = 1.1900 \times 10^5 \times T^3 - 1.5434 \times 10^4 \times T^2 + 0.7168 \times T - 902.55$
- 3) Same as in the D_{uv} Tolerance Range.