



surelight

Neon light Mini Range Specification

NE-MI-HB



Table of Contents

Introduction	03
1. Specifications & Parameters	04
1.1 Dimensions of Light	
1.2 Technical Parameters	
1.3 Optical Parameters	
2. Functions & Features	05
2.1 Product Features	
2.2 Minimum Bend Diameter	
3. Types of Connector	05
3.1 Injection-Moulded Connector	
3.2 Dual Injection-Moulded Connector	
3.3 Clasp Connector	
3.4 Snap Connector	
3.5 Swivel Connector	
3.6 Anti-wicking Ferrule	
3.7 Male & Female Connector	
4. Mounting Profile	11
4.1 Standard Aluminum Profile	
4.2 Plastic Profile	
4.3 Self-locking Aluminum Profile Ver	
4.4 Self-locking Aluminum Profile Ver. 2	
4.5 Plastic & Aluminum Combination Profile	
4.6 Cable Exit Oriented Aluminum Profile	
(Applicable to Injection-moulded Connector Only)	
4.7 Corner Aluminum Profile	
(Applicable to Injection-moulded Connector Only)	
5. Packaging	16
6. Appendix	17
6.2 Certificate	
6.3 Third-Party Test Report	
6.4 Reliability Test of Light	
6.5 Figures of Typical Characteristics	
6.6 Correlated Colour Temperature	
6.7 (X,Y) Chromaticity Diagram	
6.8 Wavelength of Colour Light	
6.9 Loading Chart	

Introduction

NE-MI is a member of the Artist of Light series with smallest smooth flat exterior that allows the most flexible and adaptable manipulations for visually appealing shapes and produces superior homogenized illumination along its full length.

Built-in protection circuit design which means single LED failure has no effect on other LEDs working in the same unit and the whole light can keep constant lighting.

NE-MI is UL/cUL, CE, TUV and RoHS compliant. Moreover, it has passed environmental resistance, optical, mechanical and electrical tests in our lab under the support of advanced experimental equipments and technology to ensure it meets the requirements of harsh environments. Also it has passed relevant tests of third party inspection authority.

Fully encapsulated in the flexible PVC chamber by utilizing consummate extrusion technology, assembled with multiple patented connectors to achieve IP68 protection, easy for installation and applicable for various circumstances.

NE-MI features excellent luminous efficacy, solid illumination, and ultra flexibility with small bend diameter in curve bending shape.

Applications:

1. Outdoor or Indoor Contour/Border Lighting
2. Architectural Outline/Decorative Lighting
3. Cove/Accent Lighting
4. Facade/Floor Lighting
5. Signage/Guide Lighting

1. Specifications & Parameters

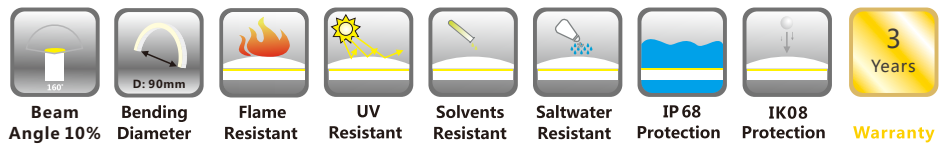

1.1 Dimensions of Light

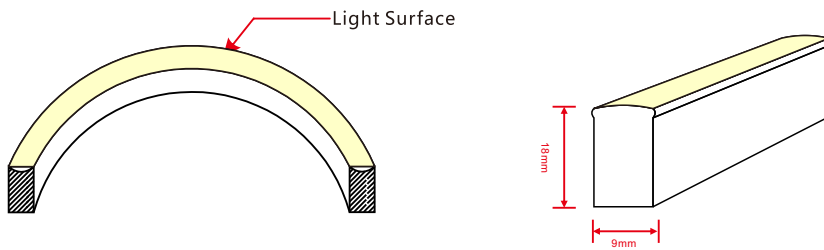

Note: Unless otherwise stated, the tolerance of the light is $\pm 0.3\text{mm}$.

1.2 Technical Parameters

Technical Parameters

Article No.	NE-MI-HB	NE-MI-HB
Colour	Red/Amber	Green/Blue/White
Working Voltage	DC24V	DC24V
Rated Power/m	3.5W	4.5W
LED Qty/m	72	72
LED Distance	13.89mm	13.89mm
Min. Cutting Unit	9LEDs(1unit)	6LEDs(1unit)
Min. Cutting Length	125mm(1unit)	83.3mm(1unit)
Continuous Length	20m	15m
Weight/m	210g	
Storage Temperature	-20 ~ 60°C	
Environmental Working Temperature	-20 ~ 45°C	
Environmental Installation Temperature	0 ~ 45°C	
IP Rating	IP68	

1.3 Optical Parameters

Photometric Data

Article No.	NE-MI-HB		NE-MI-HB		
LED Type	SMD		SMD		
Beam Angle 10%	160°		160°		
Colour	Wavelength	Lumen/m	Color	CCT	Lumen/m
Red	620-630nm	>45lm	2500K	2460±120K	>110lm
Green	520-530nm	>80lm	2700K	2725±145K	>110lm
Blue	465-475nm	>15lm	3000K	3045±175K	>120lm
Amber	585-595nm	>50lm	3500K	3465±245K	>120lm
			4000K	3985±275K	>120lm
			4500K	4503±243K	>120lm
			5000K	5029±283K	>120lm
			5700K	5669±355K	>110lm
			6500K	6532±510K	>110lm

Candle power distribution

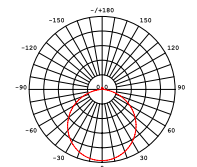

Illuminance Characteristics

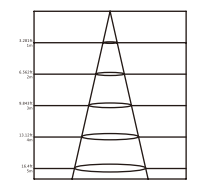

2. Functions & Features

2.1 Product Features

1. High quality and high brightness SMD LED chip.
2. Protection Circuit: Each LED Protected.
3. Variety of monochromatic lights for option including Red, Green, Blue, Amber and White light.
4. UV & flame resistant construction(PVC).
5. Flat profile, good choice for recessed mounting.
6. High colour consistency & smooth illumination with invisible light dots.
7. Ultra flexible with 90mm minimum bending diameter.
8. Easy installation and assembly with DIY accessories for joining and terminating.
9. High IP rating(IP68).
10. The product IP rate is ultimately in line with properly applied IP rated connectors.
11. Continuous length up to 20m (R, A)/ 15m (G, B, W) by powering one end.
12. Environmentally friendly & energy efficient.
13. Automated production, high reliability & long warranty.
14. 5 years life span.

2.2 Minimum Bend Diameter

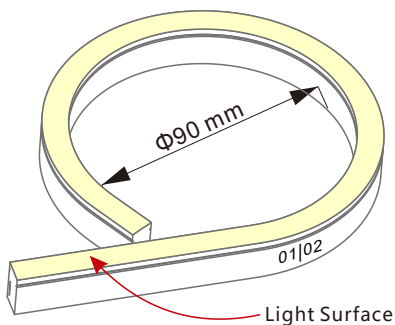

The light can only be bent laterally (opposite bend along to light surface).

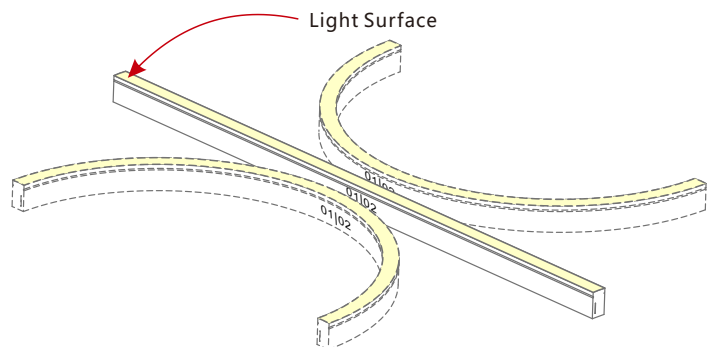

Do not bend smaller than allowed minimum bend diameter.

3. Types of Connector

3.1 Injection-moulded Connector

Note: Unless otherwise stated, the tolerance of the connector is $\pm 0.5\text{mm}$.



Injection-moulded Front Connector (bottom)

Connects light to power supply with pre-installed bottom feed cable, IP67. Cable length available in 0.3m, 1m, 3m, 5m, 10m, 15m, 20m.

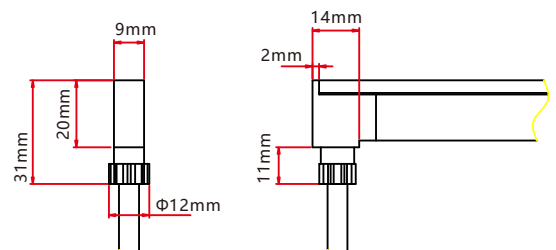

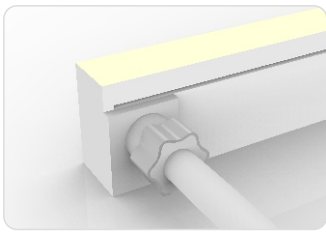

Injection-moulded Front Connector (side)

Connects light to power supply with pre-installed side feed cable, IP67. Cable length available in 0.3m, 1m, 3m, 5m, 10m, 15m, 20m.

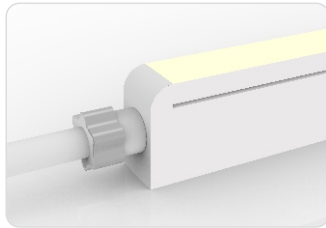
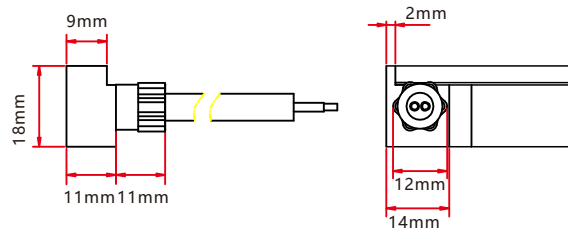

Injection-moulded Front Connector (top end)

Connects light to power supply with pre-installed end feed cable, IP67. Cable length available in 0.3m, 1m, 3m, 5m, 10m, 15m, 20m.

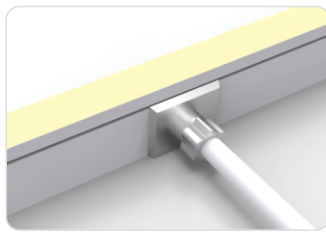
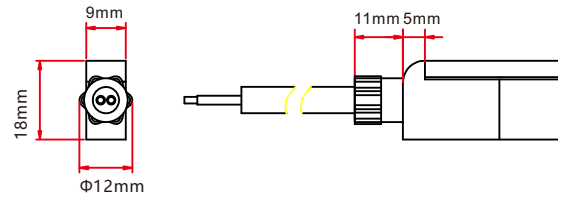

Injection-moulded Middle Feed Connector

Connects light to power supply with pre-installed end feed cable, IP67. Cable length available in 0.3m, 1m, 3m, 5m, 10m, 15m, 20m.

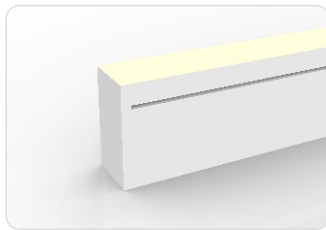
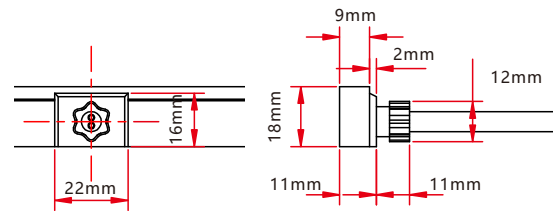

Injection-moulded End Cap

Pre-installed termination protection of the light, IP67.

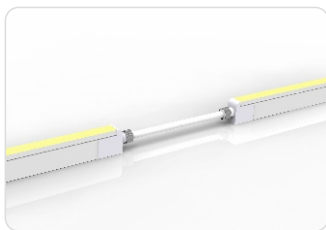
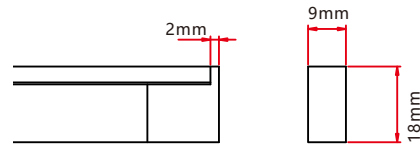

Injection-moulded Jumper

Connects two pieces of lights together with a flexible cable. IP67 Injection-moulded connector. L available in 0.3~1m.

Maximum 8 Jumpers in 20m
Maximum 4 Jumpers in 10m

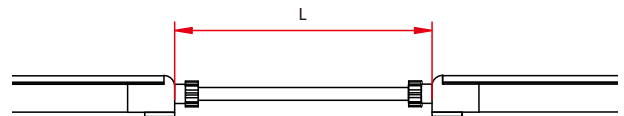

Injection-moulded T-feed

Connects two pieces of lights together with a T joint, energized from middle. IP67 Injection-moulded connector. L1 and L2 available in 0.15~0.5m. L3 available in 0.3~3m.

Maximum 8 T-feeds in 20m
Maximum 4 T-feeds in 10m

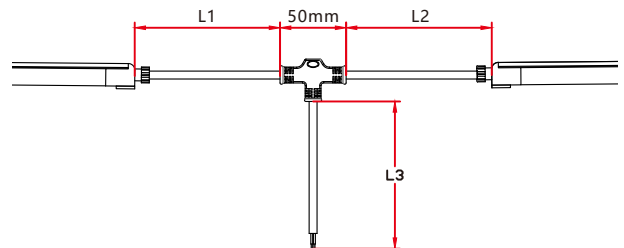

3.2 Dual Injection-moulded Connector

Note: Unless otherwise stated, the tolerance of the connector is $\pm 0.5\text{mm}$.

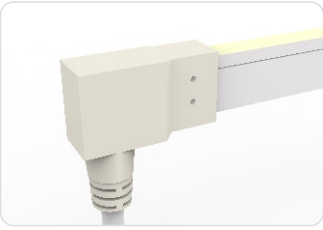

Dual Injection-moulded Front Connector (bottom)

Connects light to power supply with pre-installed bottom feed cable, IP68. Cable length available in 0.3m, 1m, 3m, 5m, 10m, 15m, 20m.

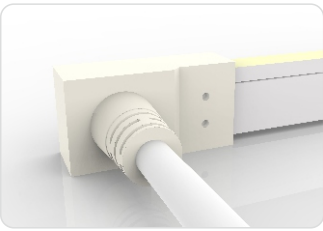
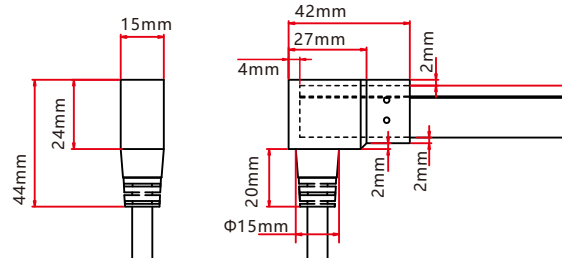

Dual Injection-moulded Front Connector (side)

Connects light to power supply with pre-installed side feed cable, IP68. Cable length available in 0.3m, 1m, 3m, 5m, 10m, 15m, 20m.

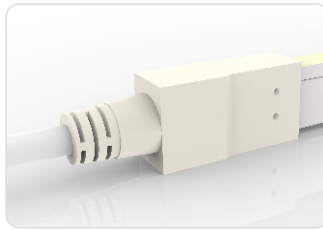
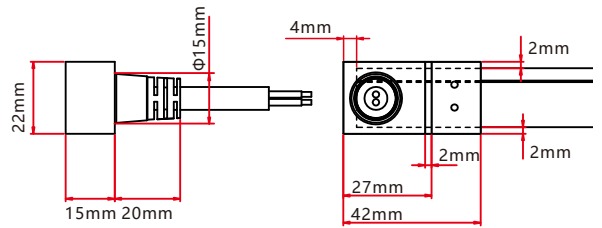

Dual Injection-moulded Front Connector (top end)

Connects light to power supply with pre-installed end feed cable, IP68. Cable length available in 0.3m, 1m, 3m, 5m, 10m, 15m, 20m.

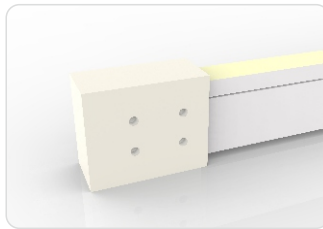
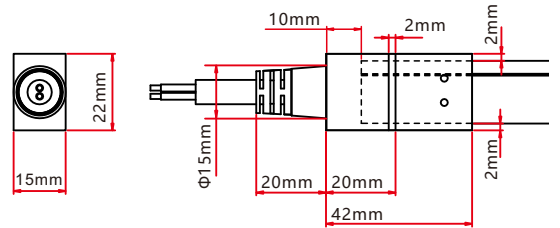

Dual Injection-moulded End Cap

Pre-installed termination protection of the light, IP68.

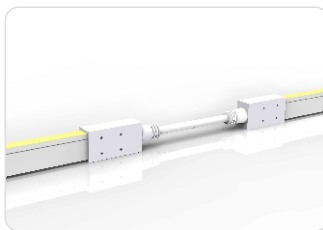
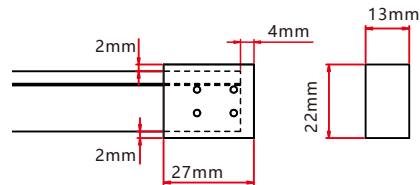

Dual Injection-moulded Jumper

Connects two pieces of lights together with a flexible cable. IP68 Dual Injection-moulded connector. L available in 0.3~1m.

Maximum 8 Jumpers in 20m
Maximum 4 Jumpers in 10m

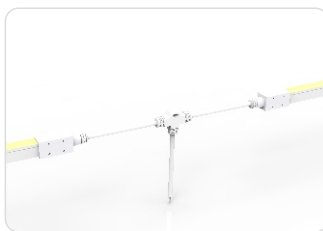
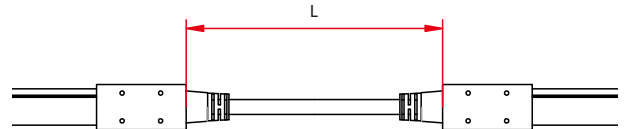

Dual Injection-moulded T-feed

Connects two pieces of lights together with a T joint, energized from middle. IP68 Dual Injection-moulded connector. L1 and L2 available in 0.15~0.5m. L3 available in 0.3-3m.

Maximum 8 T-feeds in 20m
Maximum 4 T-feeds in 10m

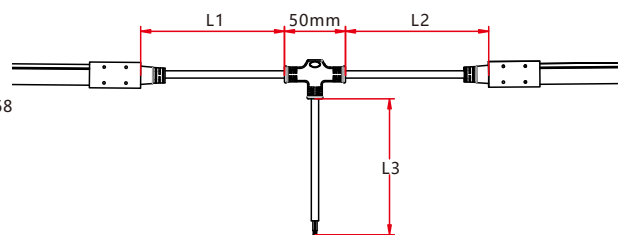

3.3 Clasp Connector

Note: Unless otherwise stated, the tolerance of the connector is $\pm 0.5\text{mm}$.

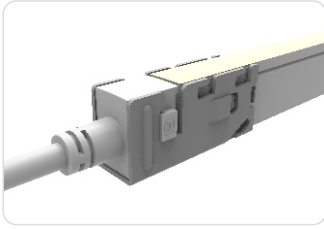

Clasp Front Connector

Connects light to power supply. IP67 DIY connector. Cable length available in 0.3m, 1m, 3m, 5m, 10m, 15m, 20m.

- Feed connector*1 (Two-pin)
- Silicone gasket*1
- U steel plate*1
- Anti-skidding clip*1

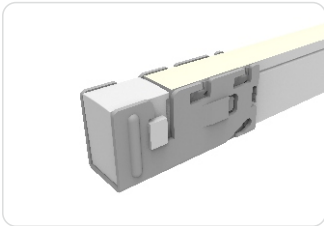
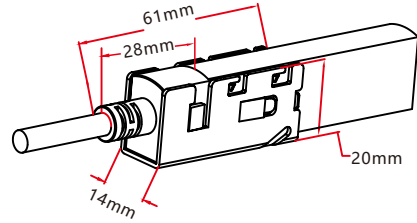

Clasp End Cap

Termination protection of the light. IP67 DIY connector.

- Tail plug*1
- Silicone gasket*1
- U steel plate*1
- Anti-skidding clip*1

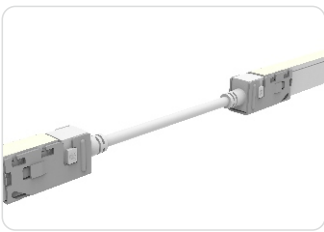
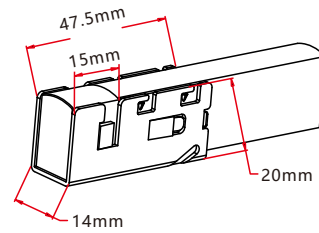

Clasp Jumper

Connects two pieces of lights together with a flexible cable. IP67 DIY connector. L available in 0.3m, 1m and 3m.

- Double-end feed connector*1 (Two-pin)
- Silicone gasket*2
- U steel plate*2
- Anti-skidding clip*2

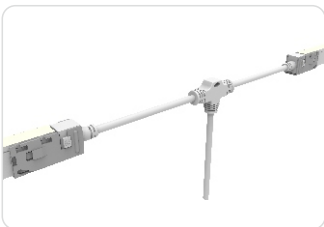
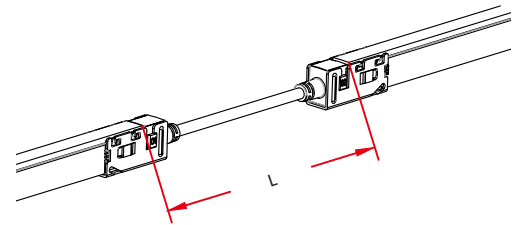

Clasp Power T-feed

Connects two pieces of lights together with a T joint, energized from middle. IP67 DIY connector. L1 and L2 available in 0.3m.

- T joint*1 (Two-pin)
- Silicone gasket*2
- U steel plate*2
- Anti-skidding clip*2

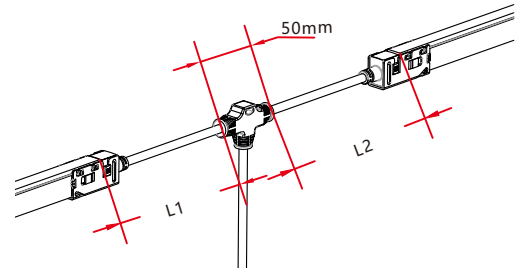

3.4 Snap Connector

Note: Unless otherwise stated, the tolerance of the connector is $\pm 0.5\text{mm}$.

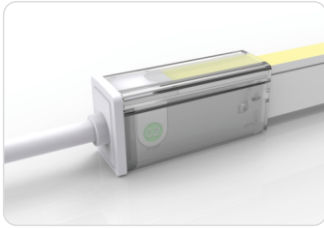

Snap Front Connector(top end)

Connects light to power supply. IP67 DIY connector. Cable length available in 0.3m, 1m, 3m, 5m, 10m, 15m, 20m.

- Feed connector*1 (Two-pin)
- Silicone gasket*1
- U steel plate*1
- Anti-skidding clip*1
- PC cover*1

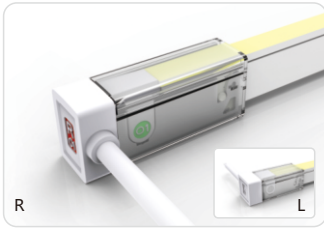
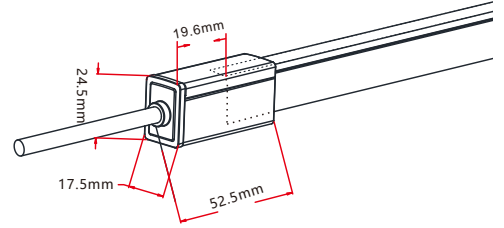

Snap Front Connector(side right/left)

Connects light to power supply. IP67 DIY connector. Cable length available in 0.3m, 1m, 3m, 5m, 10m, 15m, 20m.

- Feed connector*1 (Two-pin)
- Silicone gasket*1
- U steel plate*1
- Anti-skidding clip*1
- PC cover*1

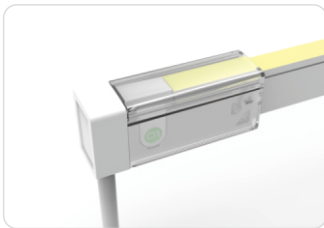
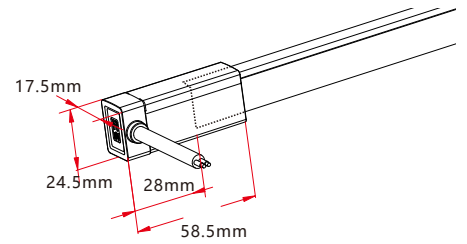

Snap Front Connector(bottom)

Connects light to power supply. IP67 DIY connector. Cable length available in 0.3m, 1m, 3m, 5m, 10m, 15m, 20m.

- Feed connector*1 (Two-pin)
- Silicone gasket*1
- U steel plate*1
- Anti-skidding clip*1
- PC cover*1

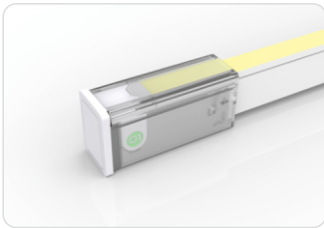
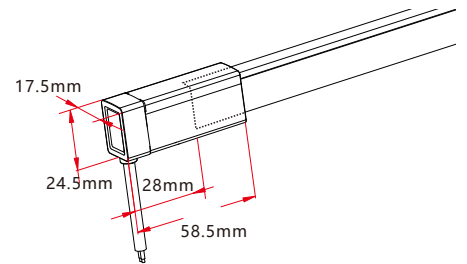

Snap End Cap

Termination protection of the light. IP67 DIY connector.

- Tail plug*1
- Silicone gasket*1
- U steel plate*1
- Anti-skidding clip*1
- PC cover*1

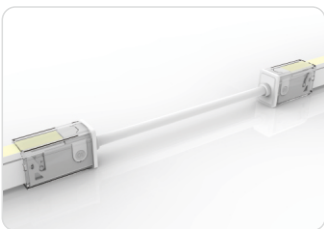
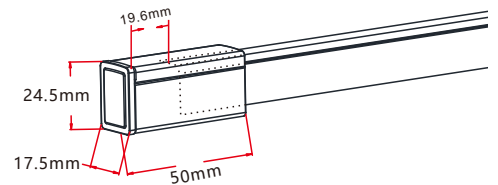

Snap Jumper

Connects two pieces of lights together with a flexible cable. IP67 DIY connector. L available in 0.3m, 1m and 3m.

- Double-end feed connector*1 (Two-pin)
- Silicone gasket*2
- U steel plate*2
- Anti-skidding clip*2
- PC cover*2

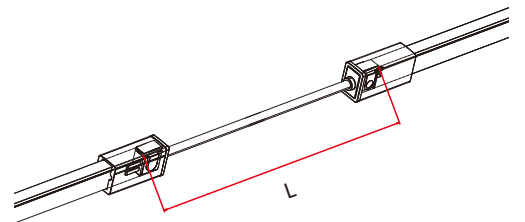

Snap Power T-feed

Connects two pieces of lights together with a T joint, energized from middle. IP67 DIY connector. L1 and L2 available in 0.3m.

- T joint*1 (Two-pin)
- Silicone gasket*2
- U steel plate*2
- Anti-skidding clip*2
- PC cover*2

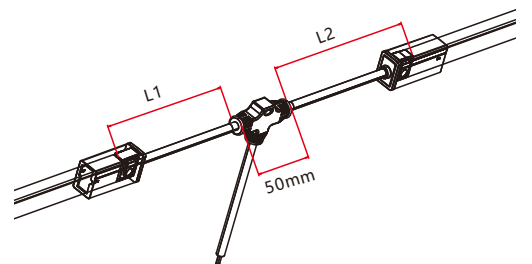

3.5 Swivel Connector

Note: Unless otherwise stated, the tolerance of the connector is $\pm 0.5\text{mm}$.

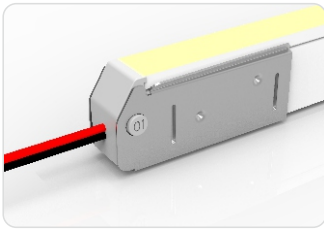

Swivel Front Connector (top end)

Connects light to power supply, IP20 DIY connector. Cable length available in 0.3m, 1m.

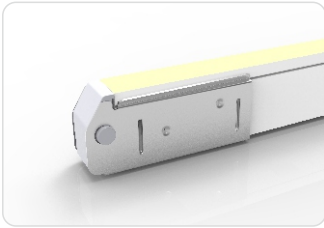
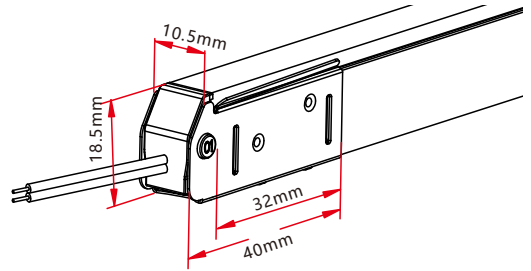

Swivel End Cap

Termination protection of the light, IP20 DIY connector.

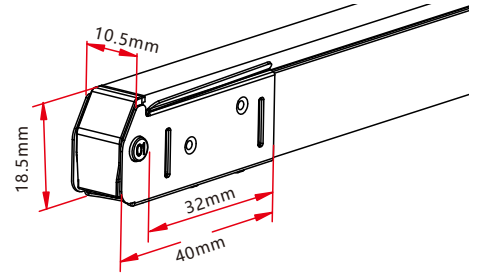

3.6 Anti-wicking Ferrule

Note: Unless otherwise stated, the tolerance is $\pm 0.5\text{mm}$.

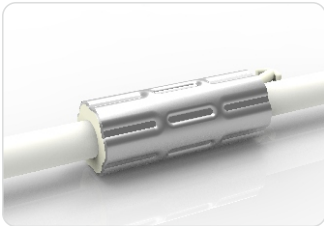

Anti-wicking Ferrule

The anti-wicking ferrule is located at 115mm ($\pm 5\text{mm}$ tolerance) from the connector on the cable.

For protection against water ingress from inside of cable wire and hence damage the light.

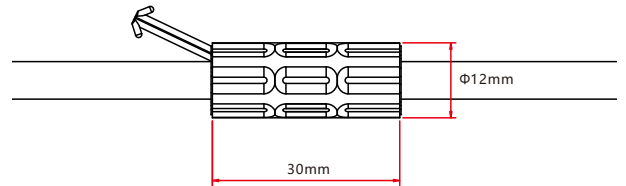

3.7 Male & Female Connector

Note: Unless otherwise stated, the tolerance is $\pm 2\text{mm}$.

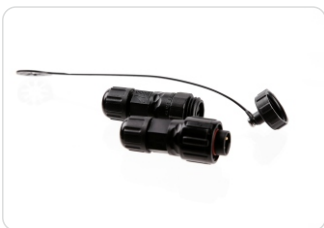

Male & female Connector

For plug and play cable junction, DIY or Pre-installed connector, IP68

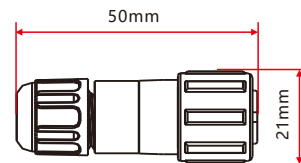

4. Mounting Profile

4.1 Locking Aluminum Profile

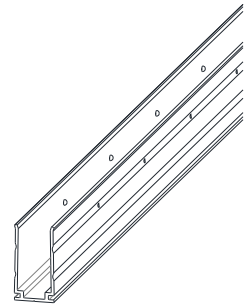
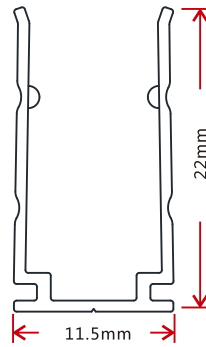
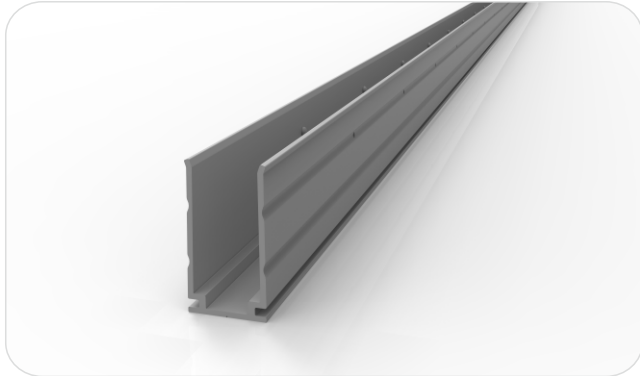

Note: Unless otherwise stated, the tolerance of the profile is $\pm 0.5\text{mm}$.

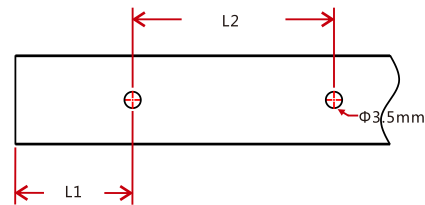

Model	W*H(mm)	Standard Length (L:mm)	L1 (mm)	L2 (mm)	Screw Hole (Φ :mm)	Hole Number	For Product
NE-MI-CH	11.5*22	35	17.5	/	$\Phi 3.5$	1	MI
		500	50	200	$\Phi 3.5$	3	MI
		1000	100	200	$\Phi 3.5$	5	MI
		2000	100	200	$\Phi 3.5$	10	MI

4.2 Plastic Profile

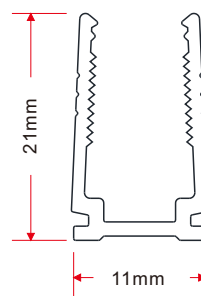

Note: Unless otherwise stated, the tolerance of the profile is $\pm 0.5\text{mm}$.

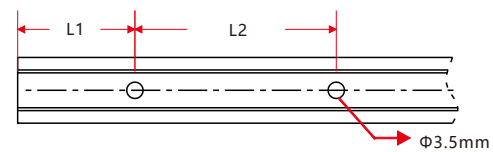

Model	W*H(mm)	Standard Length (L:mm)	L1 (mm)	L2 (mm)	Screw Hole (Φ :mm)	Hole Number	For Product
NE-MI-CH	11*21	500	50	200	$\Phi 3.5$	3	MI
		1000	100	200	$\Phi 3.5$	5	MI
		2000	100	200	$\Phi 3.5$	10	MI

4.3 Self-locking Aluminum Profile (Using with the Clip)

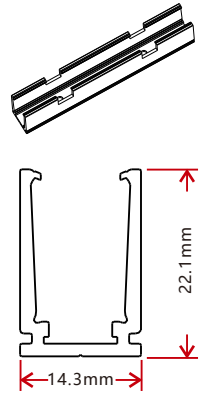
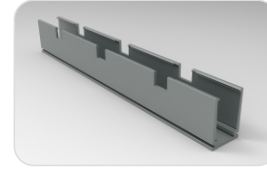
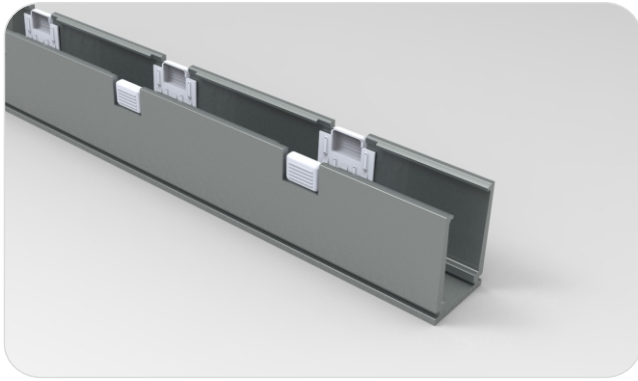

Note: Unless otherwise stated, the tolerance of the profile is $\pm 0.5\text{mm}$.

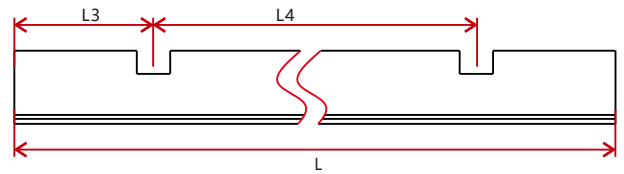
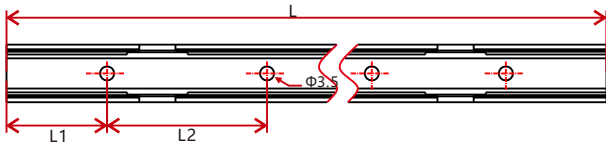

Model	W*H(mm)	Standard Length(L : mm)	L1(mm)	L2(mm)	L3(mm)	L4(mm)	Hole Screw(Φ mm)	Hole Number	Clip Number
NI-MI-CH	14.3*22.1	35	17.5	25	5	/	$\Phi 3.5$	2	1
		500	50	200	75	350	$\Phi 3.5$	3	2
		1000	100	200	150	350	$\Phi 3.5$	5	3
		2000	100	200	125	350	$\Phi 3.5$	10	6

4.4 Self-locking Aluminum Profile Ver 2.0 (Using with the Clip)

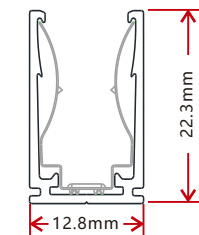
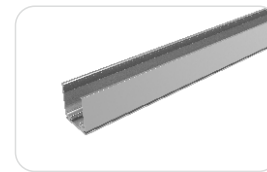

Note: Unless otherwise stated, the tolerance of the profile is $\pm 0.5\text{mm}$.

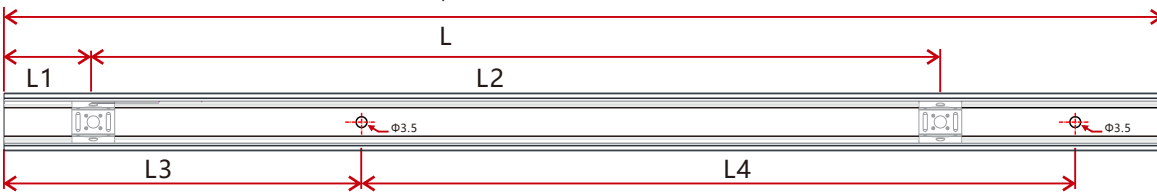

Model	W*H(mm)	Standard Length(mm)	L1(mm)	L2(mm)	L3(mm)	L4(mm)	Hole Screw(mm)	Hole Number	Clip Number
NE-MI-CH	12.8*22.3	35	17.5	/	5	25	$\Phi 3.5$	2	1
		500	25	225	50	200	$\Phi 3.5$	3	3
		1000	25	237.5	100	200	$\Phi 3.5$	5	5
		2000	25	243.8	100	200	$\Phi 3.5$	10	9

4.5 Plastic & Aluminum Combination Profile

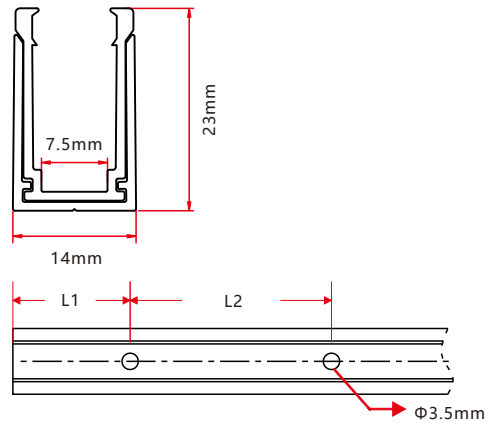

Model	W*H(mm)	Standard Length (mm)	L1 (mm)	L2 (mm)	Screw Hole (mm)	Hole Number	For Product
NE-MI-CH	14*23	35	17.5	/	Φ3.5	1	MI
		500	50	200	Φ3.5	3	MI
		1000	100	200	Φ3.5	5	MI
		2000	100	200	Φ3.5	10	MI

4.6 Cable Exit Oriented Aluminum Profile (Applicable to Injection-moulded Connector Only)

4.6.1 Self-locking Aluminum Profile Ver. 2, Middle Feed (Using with the Clip)

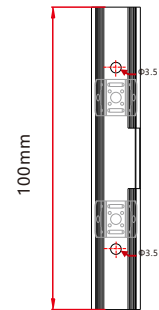
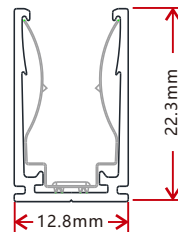
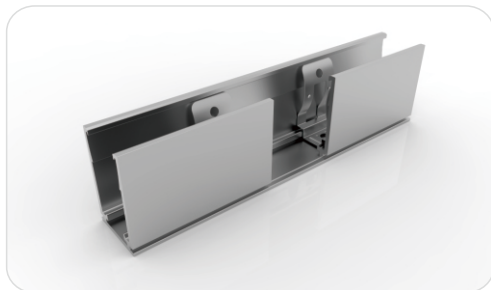

Model: NE-MI-CH

Note: Unless otherwise stated, the tolerance of the profile is ±0.5mm.

4.6.2 Self-locking Aluminum Profile Ver. 2, Side Feed From Left (Using with the Clip)

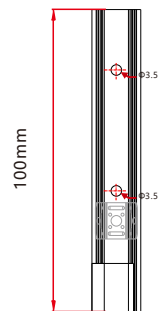
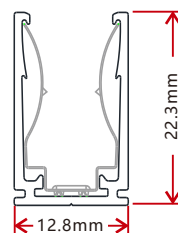

Model: NE-MI-CH

Note: Unless otherwise stated, the tolerance of the profile is ±0.5mm.

4.6.3 Self-locking Aluminum Profile Ver. 2, Bottom Feed (Using with the Clip)

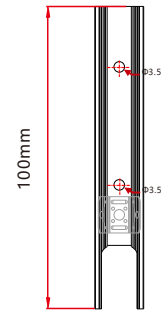
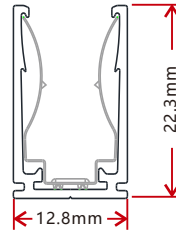
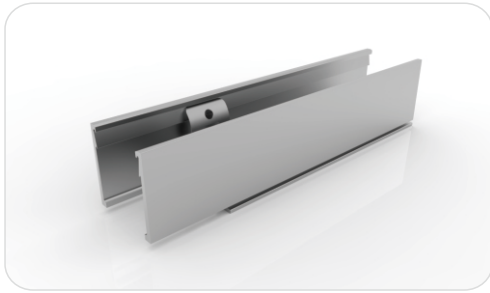

Model: NE-MI-CH

Note: Unless otherwise stated, the tolerance of the profile is $\pm 0.5\text{mm}$.

4.6.4 Self-locking Aluminum Profile Ver. 2, Side Feed From Right (Using with the Clip)

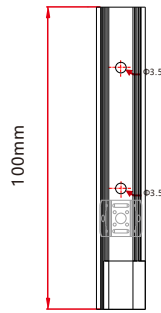
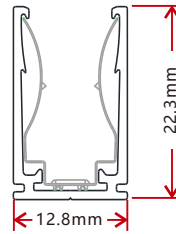
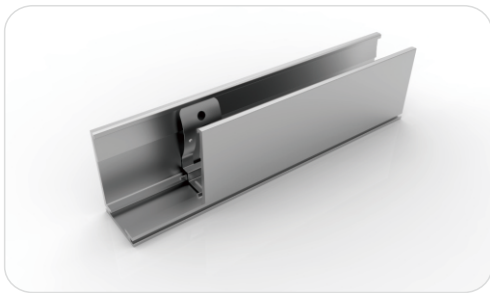

Model: NE-MI-CH

Note: Unless otherwise stated, the tolerance of the profile is $\pm 0.5\text{mm}$.

4.7 Corner Aluminum Profile (Applicable to Injection-moulded Connector Only)

4.7.1 L Shape Self-locking Aluminum Profile Ver. 2 (Using with the Clip)

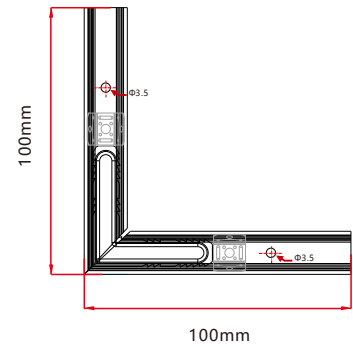
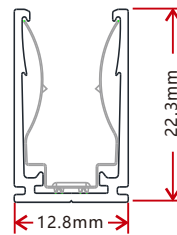

Model: NE-MI-CH

Note: Unless otherwise stated, the tolerance of the profile is $\pm 0.5\text{mm}$.

4.7.2 Inward L Shape Self-locking Aluminum Profile Ver.2 (Using with the Clip)

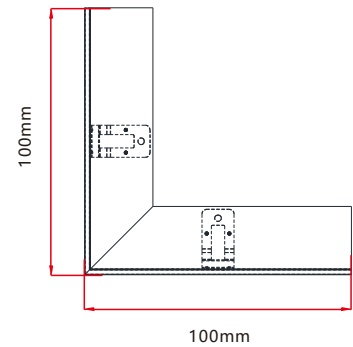
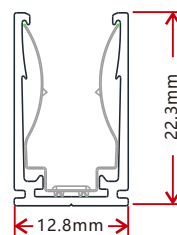

Model: NE-MI-CH

Note: Unless otherwise stated, the tolerance of the profile is $\pm 0.5\text{mm}$.

4.7.3 Outward L Shape Self-locking Aluminum Profile Ver.2 (Using with the Clip)

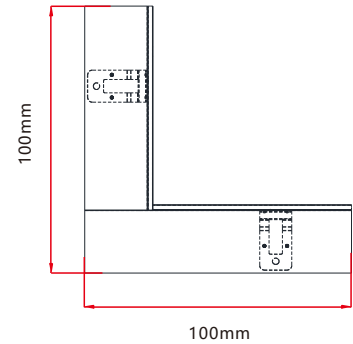
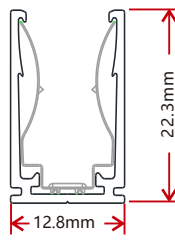
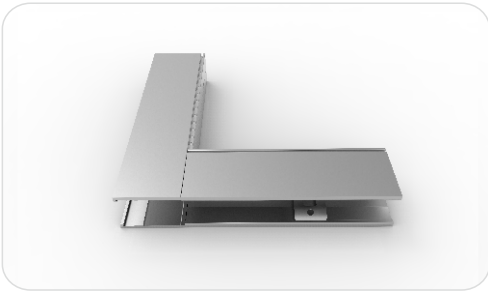

Model: NE-MI-CH

Note: Unless otherwise stated, the tolerance of the profile is $\pm 0.5\text{mm}$.

4.7.4 T Shape Self-locking Aluminum Profile Ver. 2 (Using with the Clip)

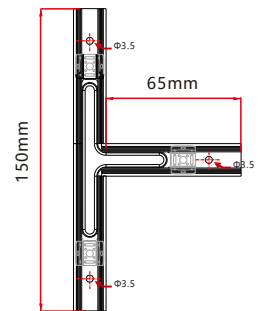
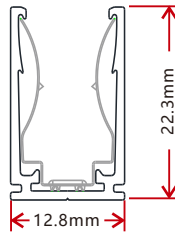
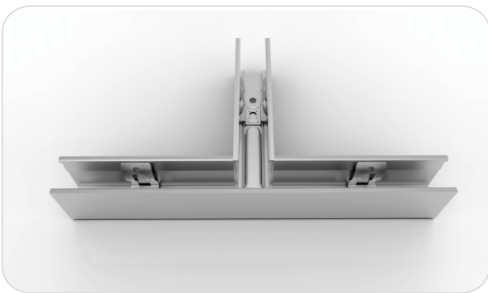

Model: NE-MI-CH

Note: Unless otherwise stated, the tolerance of the profile is $\pm 0.5\text{mm}$.

4.7.5 X Shape Self-locking Aluminum Profile Ver. 2 (Using with the Clip)

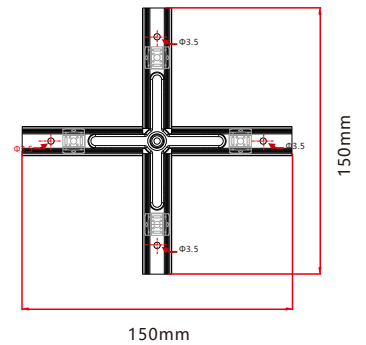
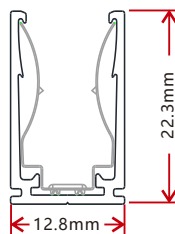
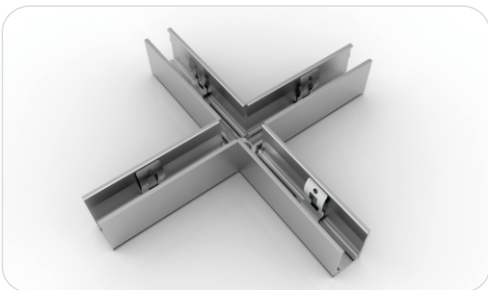

Model: NE-MI-CH

Note: Unless otherwise stated, the tolerance of the profile is $\pm 0.5\text{mm}$.

5.Packaging

Packaging Method

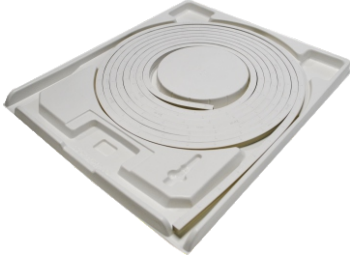

Plastic Plate

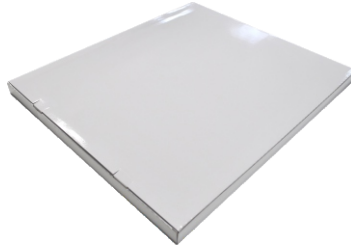

White Box



Carton



Packaging Detail

Light Length	White Box Dimension(cm)	Carton Dimension(cm)	Numbers of White Box	Carton Weight(KG)
5m	35*4.2*46	48*37*24	5	6.5
10m	45*4.2*56	58*47*24	5	12
15m	51*5.2*62	64*53*28	5	17
15m	51*5.2*62	64*53*17.5	3	12
20m	61.5*4.2*72	74*63.5*10.5	2	10
30m	68*5.2*79	81*70*12.5	2	14

6.2 Certificate

Certificating Type	Testing Organization	Certificate Serial Number	Report Reference
UL 2108	UL	20160726-E360029	E360029-20130322
CE-EMC	SGS	SZEM1702001259LMV	SZEM160600421302

6.3 Third-Party Test Report

Testing Item	Testing Organization	Report Number
RoHS	SGS	CANEC1202163502 A01
IP68: Screw type	TUV SUD	68.140.12.136.02
IP68: Clasp type	SGS	GZES140200135301 GZES140200135401 GZES140200135501 GZES140200135701 GZES140200135801
IPX8: Molding type	SGS	SZES141200357301 SZES141200357401 SZES141200357501
IPX8: Snap type	SGS	GZES160600792031
Flame retardant	TUV SUD	68.140.13.068.01
UV@340nm: Light	AOV	A002R130308065—1R01
UV@340nm: PVC	AOV	A002R130308065—2R01

>>Note: The testing reports and certificates are available from the related official website.

6.4 Reliability Test of Light

TESTING ITEM	PERFORMANCE	STANDARD/REFERENCE VALUE/DESCRIPTION
PHOTOMETRIC TESTING	Spectrum Analysis	IES LM 79 (lumen, CCT, CRI, XY, SDCM, wave length)
	Photometric Distribution	IES LM 79(lumen intensity distribution & Lux diagram)
	Lumen Maintenance & Life Time	IES LM84 & IES TM28
TEMPERATURE RISE TESTING	Normal Temperature Test	UL1598 & UL2388 & IEC60598-1 & IEC60598-2-21
	Abnormal Operation Test	UL1598 & UL2388 & IEC60598-1 & IEC60598-2-21
MECHANICS & PHYSICS TESTING	Bending Test	Manufacturer-defined, 500 cycles
	Swing Test	UL2388, >750 cycles
	Tensile Test	Manufacturer-defined, > the weight of light in
	Twist Test	maximum connection length with both ends feed
		Manufacturer-defined, >200 cycles
	Ball Impact	UL1598 & UL2388 & IEC60598-1 & IEC60598-2-21
WEATHERING TESTING	IK07 IK08	IEC62262
	Swimming Pool Water Immersion Test	GB9667, PH6.8-7.6, free chlorine 0.3-0.6mg/L
	Sea Water Immersion Test	IEC60598-1, Salinity 4%
	Salt Spray Test	IEC68-2-11
ENVIROMENT TESTING	Outdoor Exposure	Manufacturer-defined
	Flame Resistant Test	UL94
	UV Exposure Test	ASTMG 154, ISO 4892-3 , UVA@340nm
ENDURANCE & THERMAL TEST LAB	IPX5 IPX6 IPX7 IPX8	IEC60529
	Temperature Shock Test	Manufacturer-defined, -40°C-60°C (typical temperature range)
	Constant Temperature Test	Manufacturer-defined, 70°C (typical temperature)

6.5 Figures of Typical Characteristics

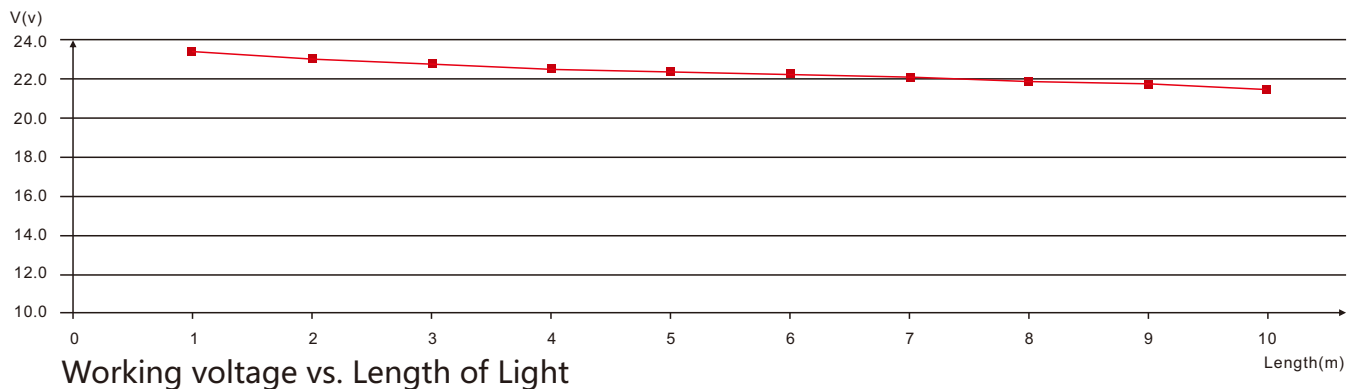
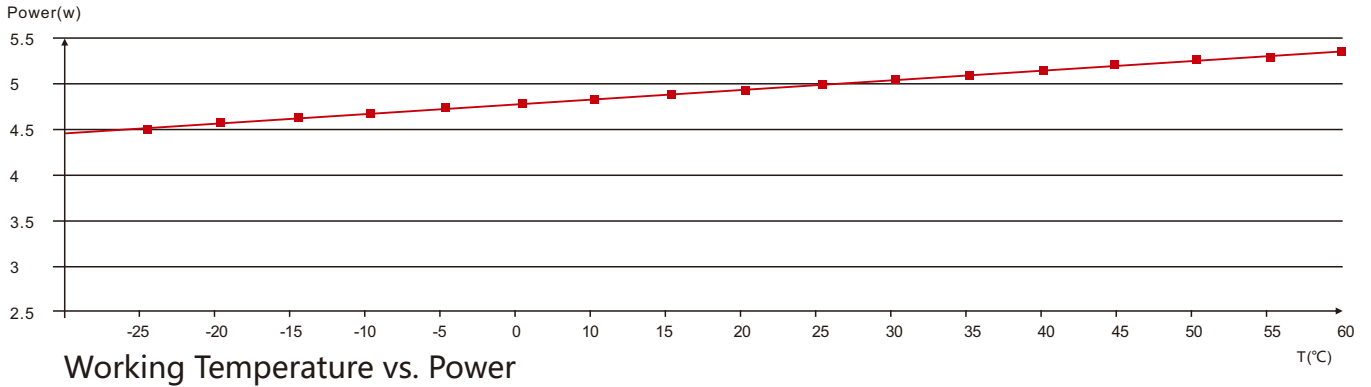

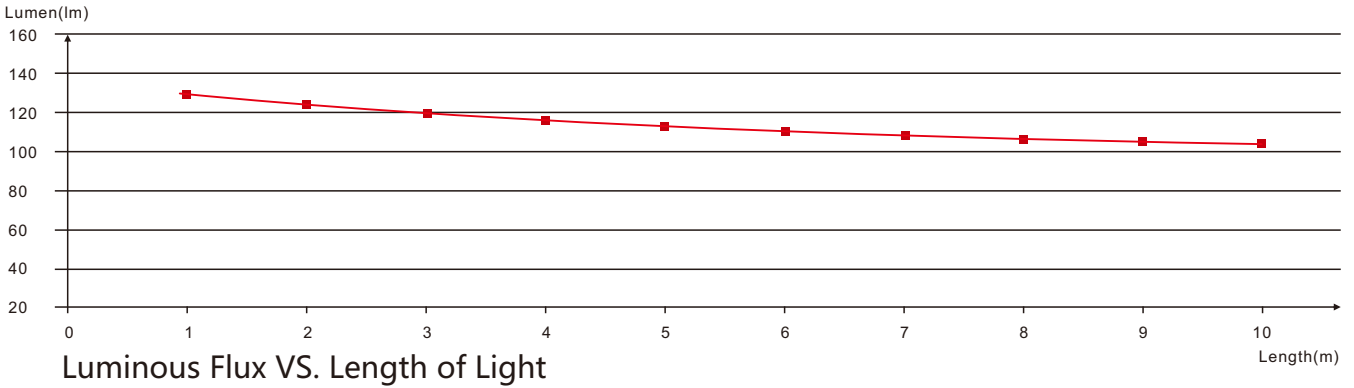

6.6 Correlated Colour

Temperature ANSI STANDARD

Nominal CCT Categories

Nominal CCT	Target CCT and tolerance(K)	Target D_{uv}	D_{uv} Tolerance Range
2200K	2238 ± 102	0.0000	Tx:CCT of the source
2500K	2460 ± 120	0.0000	For Tx < 2870K
2700K	2725 ± 145	0.0000	0.000 ± 0.0060
3000K	3045 ± 175	0.0001	For Tx ≥ 2870K
3500K	3465 ± 245	0.0005	$D_{uv}(Tx) ± 0.0060$
4000K	3985 ± 275	0.0010	where
4500K	4503 ± 243	0.0015	$D_{uv}(Tx) = 57700 \times (1/Tx)^2$
5000K	5029 ± 283	0.0020	-44.6 × (1/Tx)
5700K	5667 ± 355	0.0025	+0.00854
6500K	6532 ± 510	0.0031	

Flexible CCT (2200-6500K) $T_F^{(1)} ± \Delta T^{(2)}$ $D_{uv} T_F^{(3)}$

Remark:

- 1) T_F is chosen to be at 100K steps (2300,2400,.....,6400K), excluding the ten nominal CCTs listed in Table 1.
- 2) $\Delta T = 1.1900 \times 10^{-5} \times T^3 - 1.5434 \times 10^{-4} \times T^2 + 0.7168 \times T - 902.55$
- 3) Same as in the D_{uv} Tolerance Range.

6.7 (X,Y) Chromaticity Diagram

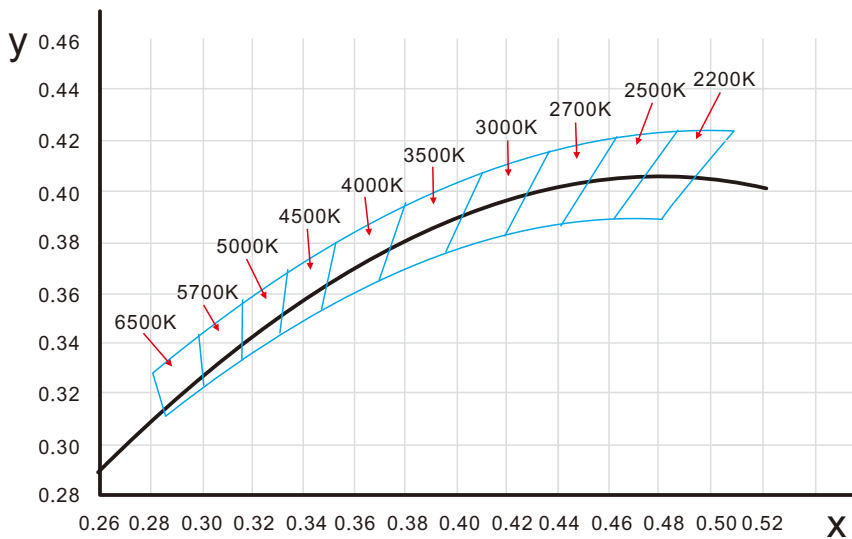

6.8 Wavelength of Colour Light

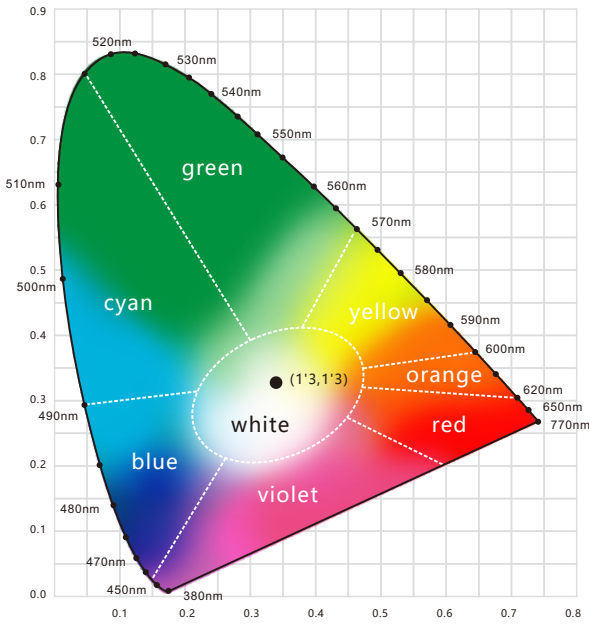

Light Color

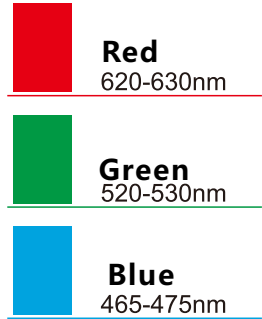

6.9 Loading Chart

Type.	Rated Power /m	Power Supply									
		35w	60w	75w	80w	75w	80w	100w	120w	150w	185w
NE-MI	3.5w(DC24V)	8m	14m	17m	18m			22m	27m	34m	40m
	4.5w(DC24V)	6m	11m	13m	14m			18m	21m	27m	30m
	4.5w(DC12V)	6m	7.5m			13m	14m	15m			
Energizing way		DC input				DC input					

Note : 1. These are the light maximum recommended running length subject to selected power supply.
 2. For example: It is recommended to use one 80W power supply loading maximum 18m light (3.5w/m) or maximum 14m light (4.5w/m) by energizing the light.